



PSEN op4H-SL Series

PILZ
THE SPIRIT OF SAFETY

► PSEN sensor technology

This document is a translation of the original document.

All rights to this documentation are reserved by Pilz GmbH & Co. KG. Copies may be made for internal purposes. Suggestions and comments for improving this documentation will be gratefully received.

Source code from third-party manufacturers or open source software has been used for some components. The relevant licence information is available on the Internet on the Pilz homepage.

Pilz®, PIT®, PMI®, PNOZ®, Primo®, PSEN®, PSS®, PVIS®, SafetyBUS p®, SafetyEYE®, SafetyNET p®, the spirit of safety® are registered and protected trademarks of Pilz GmbH & Co. KG in some countries.



SD means Secure Digital

Introduction	5
Validity of documentation	5
Using the documentation	5
Definition of symbols	5
Overview	6
Unit view	7
Scope	8
Safety	8
Intended use	8
Safety regulations	9
Safety assessment	9
Use of qualified personnel	10
Warranty and liability	10
Disposal	10
Function description	10
Basic function	10
Automatic and monitored start	11
Manual restart	12
EDM	12
Cascading	13
Project configuration	13
Maintaining the safety distance	13
Resolution	14
Protected field perimeters	14
Ambient conditions	14
Distance from reflective surfaces	15
Minimum distance between parallel, aligned safety light grids	17
Installation of several adjacent safety light grids	18
Use of deviating mirrors	18
Cascaded safety light grid	19
Minimum distance for cascaded safety light grids	19
Resolution for cascaded safety light grids	19
Installation	21
Attach safety light grids using C-brackets	22
Attach safety light grids using O-brackets	23
Attach safety light grids using L-brackets	26
Attach safety light grids using L and C-brackets	28
Cascaded safety light grid	29
Wiring	29
General guidelines	29
Connector pin assignment	30
Earthing the safety light grid	32

Cascaded safety light grid	33
Alignment	34
Alignment options depend on the installation type	34
Orientation	34
Safety light grid alignment	34
LED indicators in alignment mode	35
Commissioning	35
System connection	35
Checking the safety light grid	36
Operation	38
Display elements	38
Status information	39
Safety light grid restart	40
Malfunction	41
Regular checks and maintenance	41
Checks	41
Regular check	41
Check after plant/machine modification	41
Maintenance	42
Dimensions	42
Technical details Order no. 631120-631122	43
Technical details Order no. 631123-631125	45
Technical details Order no. 631126-631127	47
Safety characteristic data	48
Order reference	49
Safety light grid	49
Accessories	50
Appendix	51
Check list	51
Identification	53
EC declaration of conformity	53

Introduction

Validity of documentation

This documentation is valid for the product PSEN op4H-SL Series. It is valid until new documentation is published.

This operating manual explains the function and operation, describes the installation and provides guidelines on how to connect the product.

Using the documentation

This document is intended for instruction. Only install and commission the product if you have read and understood this document. The document should be retained for future reference.

Definition of symbols

Information that is particularly important is identified as follows:



DANGER!

This warning must be heeded! It warns of a hazardous situation that poses an immediate threat of serious injury and death and indicates preventive measures that can be taken.



WARNING!

This warning must be heeded! It warns of a hazardous situation that could lead to serious injury and death and indicates preventive measures that can be taken.



CAUTION!

This refers to a hazard that can lead to a less serious or minor injury plus material damage, and also provides information on preventive measures that can be taken.



NOTICE

This describes a situation in which the product or devices could be damaged and also provides information on preventive measures that can be taken. It also highlights areas within the text that are of particular importance.

**INFORMATION**

This gives advice on applications and provides information on special features.

Overview

Safety light grids in the PSEN op4H-SL Series constitute electrosensitive protective equipment (ESPE type: 4) in accordance with DIN EN 61496-1 and DIN EN 61496-2 (AOPD) for workspaces in which machines, robots, and automated systems might pose a physical danger to their operators.

Unit features

- ▶ Resolution: 24 mm
- ▶ Infrared protected field is generated
- ▶ LED indicator for status information
- ▶ Optical synchronisation of transmitters and receivers
- ▶ Connection to evaluation devices (see [System connection](#)  35])
with 5-pin M12 one-sided connector and open cable end connection to clamping sleeves
- ▶ EDM (when connected to a relay with positive-guided contacts)
- ▶ Cascading
Max. 2 slave units to one master unit
- ▶ Front panel of PMMA
- ▶ No dead zone in any protected field heights
- ▶ Dimensions of safety light grid profile: 15 x 32 mm
- ▶ Three different brackets used to install the safety light grid
 - PSEN op SL Bracket C (included) for lateral attachment to the safety light grid profile
for minimum length of installation
 - PSEN op SL Bracket O (included) for attachment to the safety light grid caps
for minimum width of installation
 - PSEN op SL Bracket L (can be combined with PSEN op SL Bracket C)
for attachment where there is strong vibration
- ▶ Die-cast zinc end caps (Zamak)

Unit view

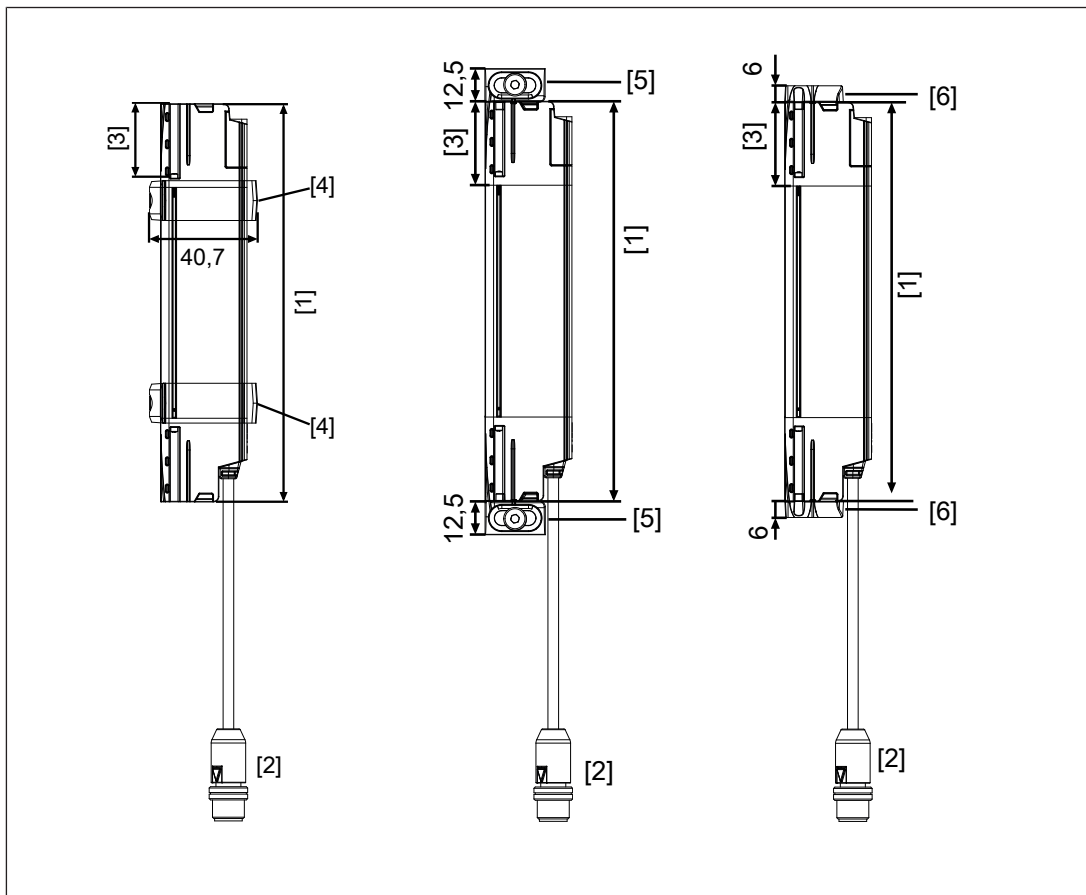
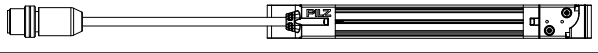
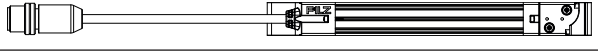
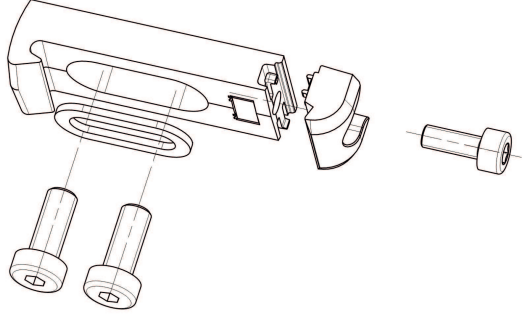
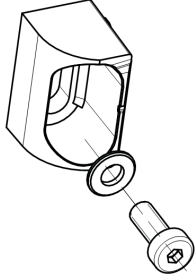

Fig.: Views of safety light grids with connection cable – Attachment using O-bracket, C-bracket or L-bracket

Legend

- [1] Protected field height
- [2] Connection cable, M12 connector
- [3] Cover for the contacts used to connect a slave unit when cascading
- [4] C-bracket
- [5] O-bracket
- [6] L-bracket

Scope

Quant-ity	Description	Illustration
1	Transmitter	
1	Receiver	
4/6	<p>▶ C-bracket</p> <ul style="list-style-type: none"> – with slotted hole washer and hexagon socket cylinder head screws 2 x M4x10 DIN 7984, 1 x M3x8 DIN EN ISO 12474 – 4 brackets for protected field height 150 mm – 540 mm – 6 brackets for protected field height 600 mm – 1200 mm 	
4	<p>▶ 2 O-brackets</p> <ul style="list-style-type: none"> – with washer and hexagon socket cylinder head screw M4x10 DIN 7984 	

Safety

Intended use

Safety light grids of the PSEN op4H-SL Series are electrosensitive protective equipment of the 4. They are used to protect personnel and systems. The safety light grids are designed for

- ▶ securing hazardous areas within buildings and
- ▶ securing access within buildings with a resolution of 24 mm.

The safety light grid may only be used for personal protection on machinery if

- ▶ the hazardous state can be removed by the safety light grid and
- ▶ the starting of the machine is controlled by the safety light grid and
- ▶ the safety assessment prescribes no better resolution than 24 mm.

The safety level PL e (Cat. 4)/SIL CL 3 is only achieved if

- ▶ the safety outputs use 2-channel processing.

The safety light grid is not equipped with a restart interlock.

If the safety assessment necessitates a restart interlock, this feature must be ensured within the plant's programmable safety system. The system may not be started in the hazardous area following a protection violation if personnel are still in the hazardous area.

Prevent circumvention of the protected field. This means that other safety devices and safeguards may be required in addition to the safety light grid. These should be determined via a safety assessment based on the specific application area and specific local conditions (e.g. official specifications).

Refer to IEC/TS 62046 to determine other necessary safeguards for securing the hazardous area.

Their application must fulfil the site's relevant national regulations (e. g. EN 60204-1, NFPA 79:17-7).

The following is deemed improper use in particular:

- ▶ Any component, technical or electrical modification to the product
- ▶ Use of the product outside the areas described in this manual
- ▶ Use of the product outside the technical details (see [Technical details](#) [ 43]).



NOTICE

EMC-compliant electrical installation

The product is designed for use in an industrial environment. The product may cause interference if installed in other environments. If installed in other environments, measures should be taken to comply with the applicable standards and directives for the respective installation site with regard to interference.

Safety regulations

Safety assessment

Before using a unit it is necessary to perform a safety assessment in accordance with the Machinery Directive.

Functional safety is guaranteed for the product as a single component. However, this does not guarantee the functional safety of the overall plant/machine. In order to achieve the required safety level for the overall plant/machine, define the safety requirements for the plant/machine and then define how these must be implemented from a technical and organisational standpoint.

Use of qualified personnel

The products may only be assembled, installed, programmed, commissioned, operated, maintained and decommissioned by competent persons.

A competent person is a qualified and knowledgeable person who, because of their training, experience and current professional activity, has the specialist knowledge required. To be able to inspect, assess and operate devices, systems and machines, the person has to be informed of the state of the art and the applicable national, European and international laws, directives and standards.

It is the company's responsibility only to employ personnel who

- ▶ Are familiar with the basic regulations concerning health and safety / accident prevention,
- ▶ Have read and understood the information provided in this description under "Safety"
- ▶ Have a good knowledge of the generic and specialist standards applicable to the specific application.

Warranty and liability

All claims to warranty and liability will be rendered invalid if

- ▶ The product was used contrary to the purpose for which it is intended
- ▶ Damage can be attributed to not having followed the guidelines in the manual
- ▶ Operating personnel are not suitably qualified
- ▶ Any type of modification has been made (e.g. exchanging components on the PCB boards, soldering work etc.).

Disposal

- ▶ In safety-related applications, please comply with the mission time T_M in the safety-related characteristic data.
- ▶ When decommissioning, please comply with local regulations regarding the disposal of electronic devices (e.g. Electrical and Electronic Equipment Act).

Function description

Basic function

The safety light grid consists of a transmitter and a receiver.

Their shape and design

- ▶ protect the transmitter and receiver from external damage
- ▶ protect the safety light grid from malfunctions caused by vibration (see [Technical details, environmental data section](#) [ 43]).

The protected area is covered by infrared light beams, which are emitted from the transmitter to the receiver. The protected field thus produced is able to detect an opaque object.

The control and monitoring of the transmitted and received infrared rays is performed by microprocessors.

The output signal switching devices (OSSDs) switch to the OFF state when one of the following conditions is met:

- ▶ one or more light beams are interrupted by an object, a body part, or an opaque object that is at least as large as the resolution (24 mm) covered by the safety light grid,
- ▶ an error is detected by one of the OSSDs,
- ▶ or interfering light is detected.

If an error occurs, the OSSDs remain in the OFF state. The state can be returned to the ON state only after a successful [restart](#)  [40](#) of the safety light grid.

The safety light grid in the PSEN op4H-SL Series offers the following functions:

- ▶ Automatic start
- ▶ Monitored start
- ▶ EDM (when connected to a relay with positive-guided contacts)
- ▶ Cascading

Transmitters and receivers are each electrically connected with a cable with an M12 connector that is assigned to the transmitter and receiver on the LED side.

The transmitter and receiver are optically synchronised and therefore need not be directly connected to each other.

Information about the operating status of the safety light grid and any error state is provided by means of LEDs.

The indicators are described in the [Status Information](#)  [38](#) section.

Automatic and monitored start

Automatic start

During safety light grid commissioning, the safety light grid starts automatically, and the OSSDs switch to the ON state under the following conditions:

- ▶ both OSSDs are wired correctly **and**
- ▶ no error has occurred **and**
- ▶ the protected field is clear.

If the protected field is violated, the OSSDs switch to the OFF state.

Monitored start

The OSSDs automatically switch to the ON state during operation under the following conditions:

- ▶ both OSSDs are wired correctly **and**
- ▶ no error has occurred **and**
- ▶ the protected field is clear **and**
- ▶ at least 80 ms have elapsed since switching to the OFF state **and**
- ▶ the start button has been operated for at least 0.5 s. The start occurs with a falling edge.

Manual restart

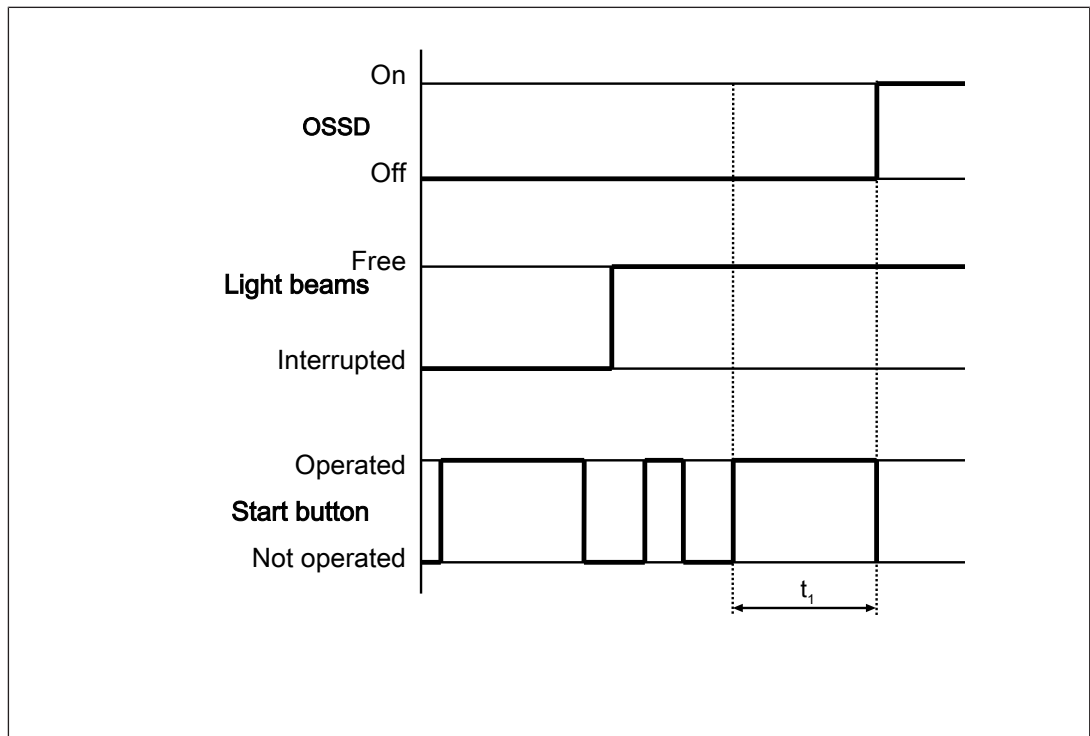

Fig.: Timing diagram for manual restart

Legend

t_1 Operate the start button for 0.5 s to 5 s to trigger a manual restart

EDM

Contactors outside the safety light grid can be monitored (External Device Monitoring = EDM, also known as feedback loop monitoring).

EDM only needs to be activated if the contactors are controlled directly.

A test is performed to see that the N/C contacts switch if the state of the OSSD changes and so is used to monitor and detect malfunctions on the contactors. If a malfunction is detected, the safety light grid switches to a safe state and stops the connected machine. This check is carried out each time the OSSD is triggered and before restarting.

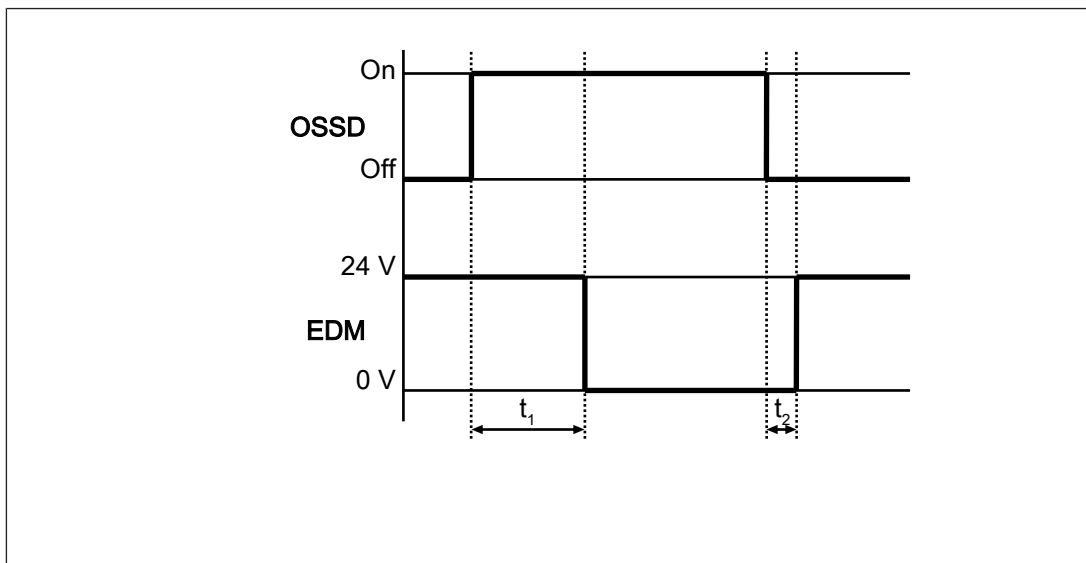

Fig.: Timing diagram for EDM

Legend

- t_1 After the OSSD outputs are switched on, the EDM circuit must open within 350 ms
 t_2 After the OSSD outputs are switched off, the EDM circuit must close within 100 ms

Use control elements whose dynamics match the times stated at t_1 and t_2 .

The function is activated or deactivated with the [Wiring](#)  30].

Cascading

During cascading, the safety outputs of a safety light grid are connected to an evaluation device. A second safety light grid can be connected to this first safety light grid. The first safety light grid is the master unit; the safety light grid connected to the master unit is the slave unit.

- ▶ Max. 2 slave units to one master unit
- ▶ Max. overall length: 3600 mm
- ▶ The master unit collects the results from the slave units and ensures synchronisation between them, so that mutual interference is avoided
- ▶ Each transmitter/receiver in the PSEN op4H-SL Series can be used both as a master unit and a slave unit
- ▶ Up to three areas can be monitored when two safety outputs are connected

Project configuration

Maintaining the safety distance

The minimum distance between the safety light grid and the hazardous machine component should be such that the operator cannot reach the hazardous area until the hazardous machine part has come to a standstill.

In accordance with the standard

- ▶ EN ISO 13855

this distance depends on three factors:

- ▶ Response time of the safety light grid
Interval between interruption of the beams and the OSSD's change to the OFF state
- ▶ Machine's stopping time
Interval between the change of the OSSD to the OFF state and the stopping of the hazardous machine movement (including the reaction time of the connected relay)
- ▶ Approach speed

The speed with which the object to be detected is nearing the hazardous area in mm/s

The general formula for calculating the minimum distance in accordance with EN ISO 13855 is as follows:

$S = K * (t_1 + t_2) + C$	
S	Minimum distance in mm, measured from the start of the protected field to the danger source
K	Approach speed with which the object to be detected is nearing the hazardous area in mm/s K = 1600 mm/s when S > 500 mm K = 2000 mm/s when S ≤ 500 mm
t ₁	Response time of the safety light grid in seconds Time it takes for the signal at the OSSD output on the safety light grid to change once a protected field has been violated
t ₂	Machine's stopping time in seconds The time required for the machine to stop after the signal at the OSSD output changes
C	Additional distance of 128 mm for safety light grids with hand protection

Resolution

The safety light grids may only be used for protected fields in which a detection capability of 24 mm is sufficient.

Protected field perimeters

During planning, ensure sufficient protected field height to secure the danger zone.

The protected field perimeter is defined in [dimensions](#)  42].

Ambient conditions

- ▶ Install the safety light grids in an environment that corresponds to the environmental data provided in the [Technical details](#)  43].
- ▶ Do not install the safety light grid near particularly intense and/or flashing light sources; this applies to the receiver in particular.

- ▶ The transmitter of one safety light grid must not interfere with the receiver of another safety light grid.
- ▶ The transmitters and receivers of two different safety light grids must not be synchronised.
- ▶ Avoid strong electromagnetic interference when operating the safety light grid.
- ▶ When operating the safety light grid, avoid the development of smoke, mist, or dust that would reduce the grid's operating range.

Distance from reflective surfaces

If there are reflective surfaces near the beams emitted from the safety light grid (whether from above, below, or from the side), passive reflections can cause an object within the protected field to remain undetected (see diagrams).

This means that there must be a certain minimum distance between the safety light grid and reflective surfaces.

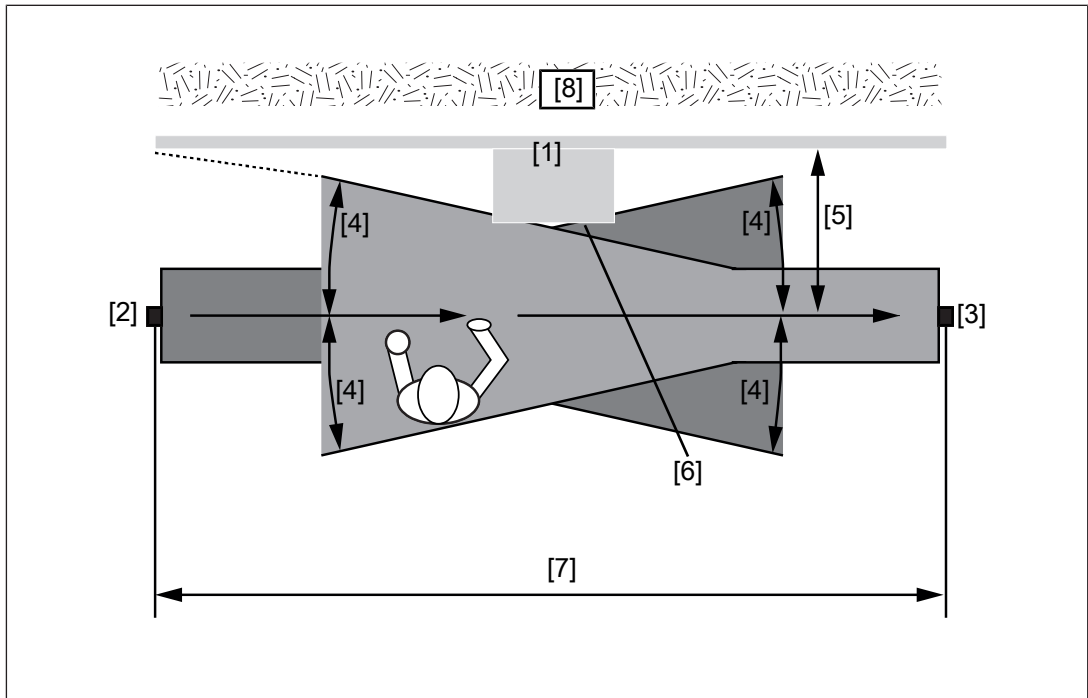
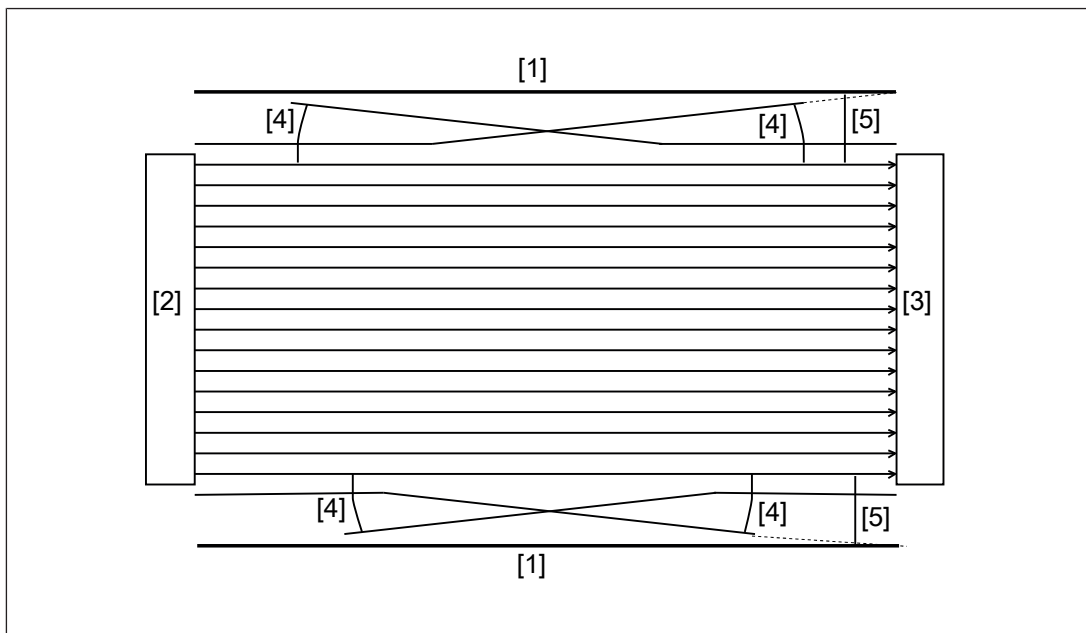

Fig.: Interference with the function of the safety light grid due to reflective surfaces – top view



Legend

- [1] Reflective surface
- [2] Transmitter
- [3] Receiver
- [4] Half of the [opening angle](#) [43] (= α) of the light beams emitted by the safety light grid
- [5] Minimum distance D between the safety light grid and the reflective surface
- [6] Passive reflections on the surface
- [7] Distance between transmitter and receiver (working distance)
- [8] Hazardous area

The minimum distance D depends on two factors:

- ▶ Working distance between transmitter and receiver
- ▶ the maximum [opening angle](#) [43] of the light beams emitted by the safety light grid at:
 $5^\circ = \pm 2.5^\circ$ in relation to the optical axis

Minimum distance of the safety light grid to reflective surfaces

The formula for calculating the minimum distance D is:

- ▶ For a working distance of less than 3 m: $D = 0.131 \text{ m}$
- ▶ For a working distance of 3 m or more: $D = \text{working distance in m} \times \tan \alpha$

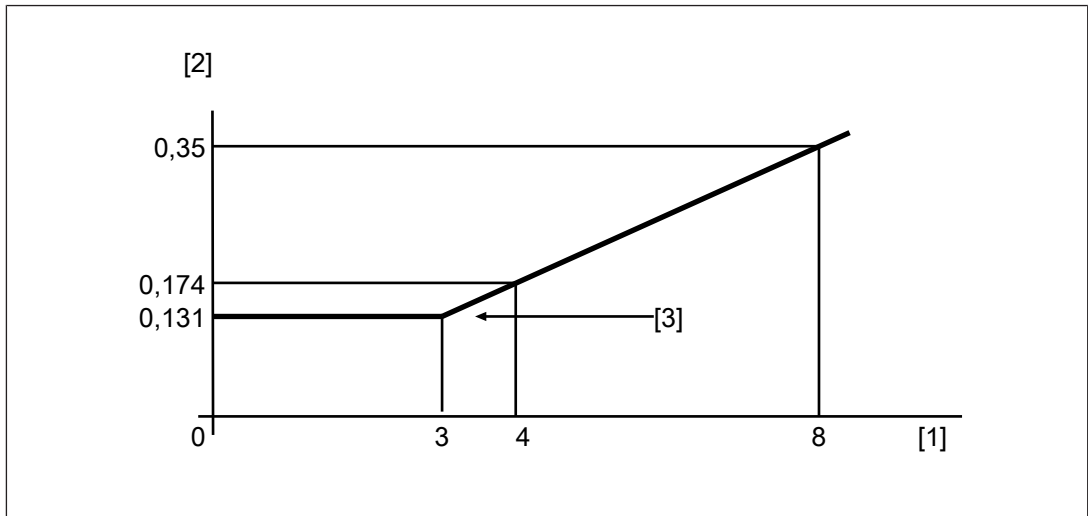

Fig.: Relationship between minimum distance and working distance

Legend

- [1] Working distance in m
- [2] Distance from reflective surfaces in m
- [3] Minimum distance D

Minimum distance between parallel, aligned safety light grids

Please note:

Safety light grids that are installed so as to be parallel and aligned must have a minimum spacing corresponding to the information in [distance to reflective surfaces \[15\]](#).

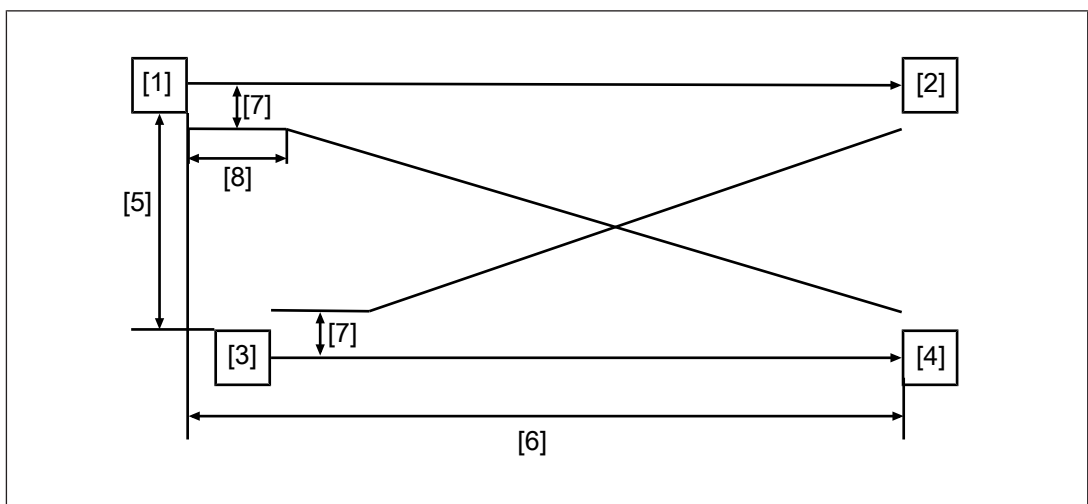

Legend

- [1] Transmitter from the first safety light grid
- [2] Receiver from the first safety light grid
- [3] Transmitter from the second safety light grid
- [4] Receiver from the second safety light grid

- [5] Minimum distance of $2 \times D$ between two safety light grids that are aligned
- [6] Working distance
- [7] Minimum distance D , dependent on the working distance
- [8] Working distance (= 3 m) with constant minimum distance $D = 0.131$ m

Installation of several adjacent safety light grids

An arrangement of several adjacent safety light grids can be achieved by various methods. When installing of several adjacent safety light grids, note the [ambient conditions](#)  14].

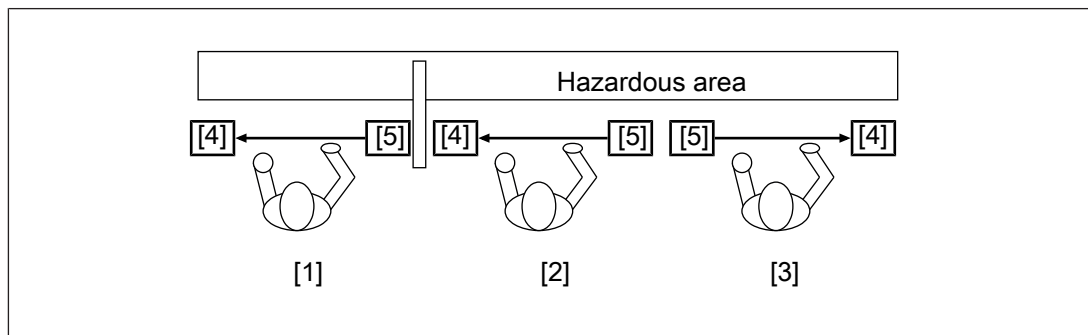



Fig.: Using several adjacent safety light grids

Legend

- [1] Connecting the safety light grid with an opaque surface to shield the safety light grid on the right
- [2] Connection of the safety light grid aligned with [1]
- [3] Connection of safety light grid without shielding, but in the orientation opposite to [2]
- [4] Receiver
- [5] Transmitter

Use of deviating mirrors

Danger zones with different but adjacent access sides can be monitored using a safety light grid in conjunction with [deviating mirrors](#)  51].

The diagram below shows an example solution for monitoring three different access sides using two deviating mirrors. The deviating mirrors must be positioned at an angle of 45° to the beams from the safety light grid.

When using deviating mirrors, please note:

- ▶ Even a minor angular displacement of the mirror can lead to misalignment, adversely affecting or preventing the function of the safety light grid.
- ▶ The minimum safety distance to the danger zone must be maintained for all sections of the light path.
- ▶ Use of a single deviating mirror reduces the operating range by about 20%. This percentage increases when an additional deviating mirror is used (more detailed information is provided in the technical data for the relevant mirror). Please consider this reduction when positioning the safety light grid.

- ▶ The height of the deviating mirror must be at least 100 mm greater than the protected field height of the safety light grid.
- ▶ You should not use more than one mirror per device.
- ▶ Any dust or dirt on the mirror's reflective surface will drastically reduce the operating range.

Number of mirrors per device	Maximum operating range [📖 43] in m
1	4.8 m

Cascaded safety light grid

Minimum distance for cascaded safety light grids

When safety light grids are cascaded with two slave units, be sure to maintain the minimum distance between the master unit and slave unit 2.

Width of the protected field	Minimum distance
< 3 m	263 mm
> 3 m	see Minimum distance between parallel, aligned safety light grids [📖 17]

Resolution for cascaded safety light grids

When safety light grids are cascaded, the resolution may vary from that stated in the technical details, depending on the brackets used for installation.

Installation using C-brackets

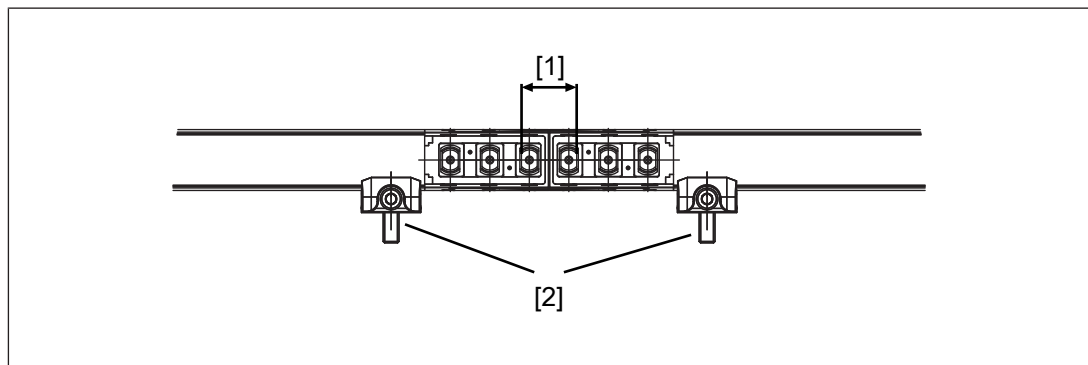

Legend

- [1] Unchanged resolution of 24 mm at the ends of the safety light grid
- [2] C-brackets

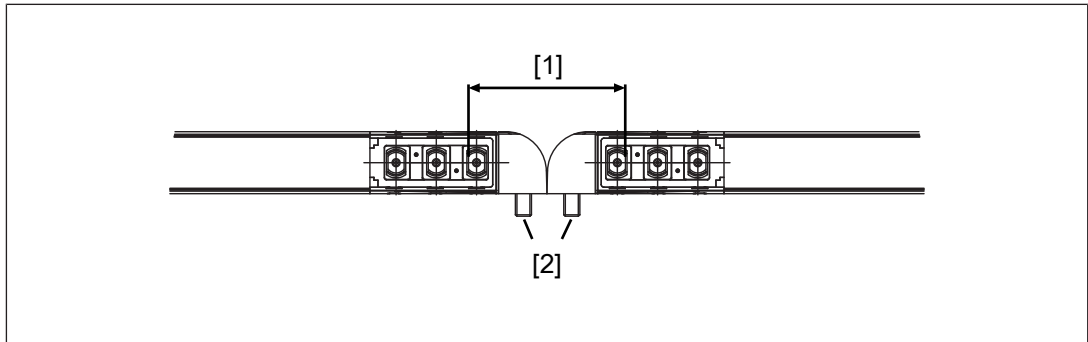
Installation using O-brackets**Legend**

- [1] Reduced resolution of 40 mm at the ends of the safety light grid
- [2] O-brackets

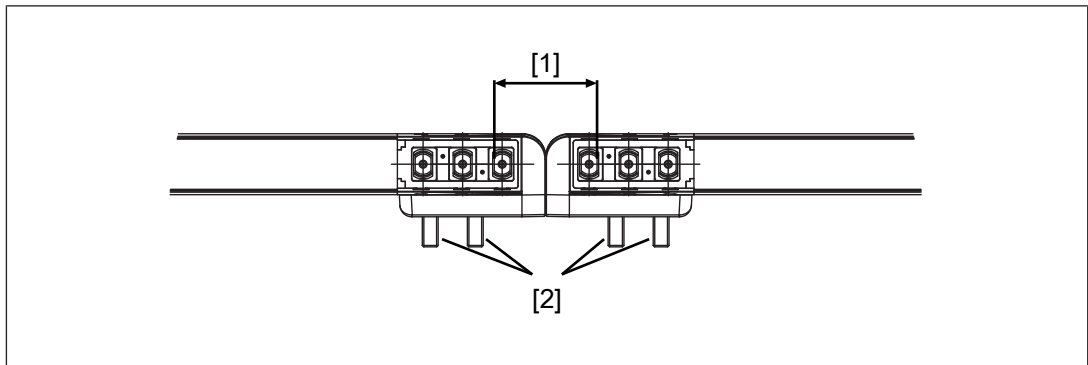
Installation using L-brackets**Legend**

- [1] Reduced resolution of 26 mm at the ends of the safety light grid
- [2] L-brackets

Cascading with master/slave units arranged at right angles (with C or L-brackets)

When safety light grids are arranged at right angles there is a reduced resolution of 18 mm at the ends of the safety light grid.

Use C-brackets or L-brackets when safety light grids are arranged at right angles.

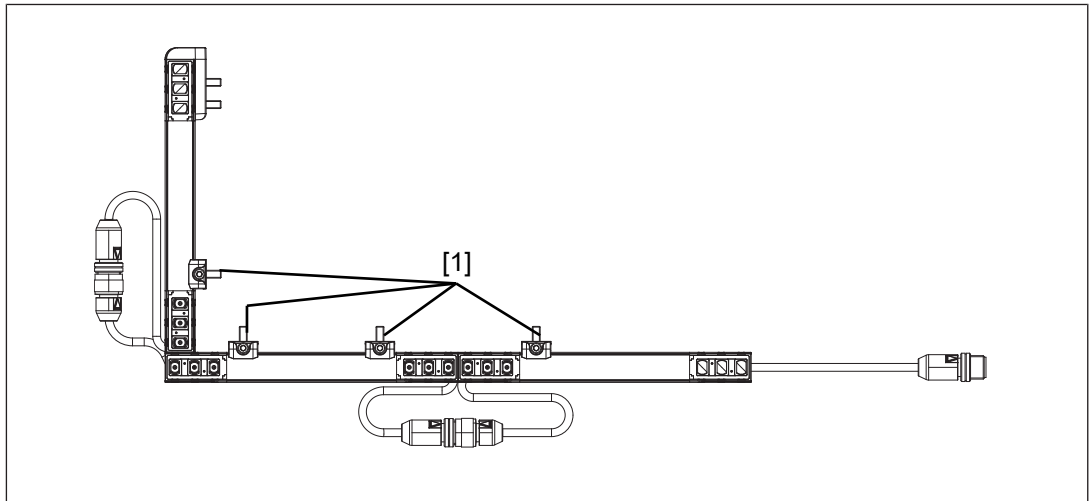
**Legend**

[1] C or L-brackets

Installation

Please note:

- ▶ The optical surfaces of the transmitter and receiver must be parallel to each other and oriented opposite to each other.
- ▶ The connection sides of the transmitter and receiver must be on the same side and at the same height (see diagram).

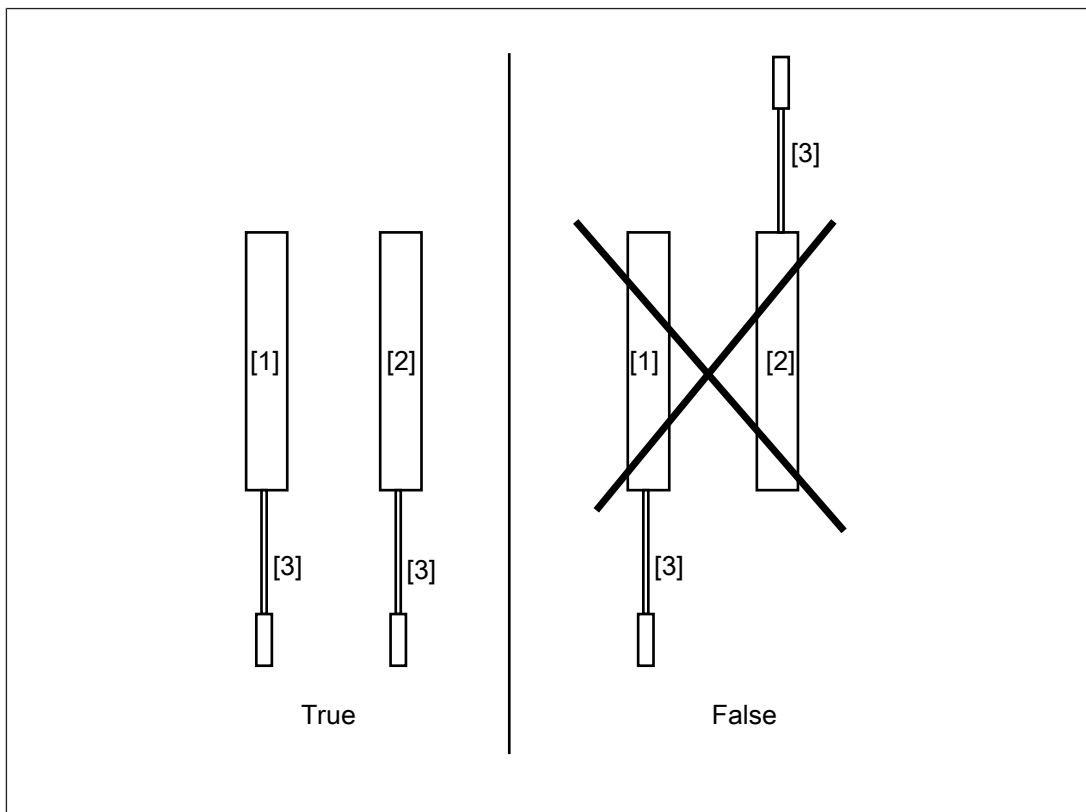

Legend

- [1] Transmitter
- [2] Receiver
- [3] Connection cable

- ▶ The distance between the transmitter and receiver must be within the operating range of the safety light grid used (see [Technical details](#) [43]).

Attach safety light grids using C-brackets

For protected field heights up to 600 mm use 2 C-brackets; with protected field heights > 600 mm we recommend 3 C-brackets. Install the third C-bracket in the same way, in the middle between the 2 C-brackets as additional support.

1. Make two drill holes in the mounting surface as shown [1] and install the C-brackets [4]. Tighten the M4 screws to 1,2 Nm.
2. Slightly loosen the M3 screw [3] and open the clamping jaws of both C brackets.
3. At a slight angle, insert the transmitter/receiver into the C-brackets at the non-connection end [4]. Use the corresponding longitudinal slot on the profile.
4. Turn the transmitter/receiver until the transmitter/receiver lock into position in the C-bracket at the non-connection end.
5. Tighten the M4 screws to 1,2 Nm.

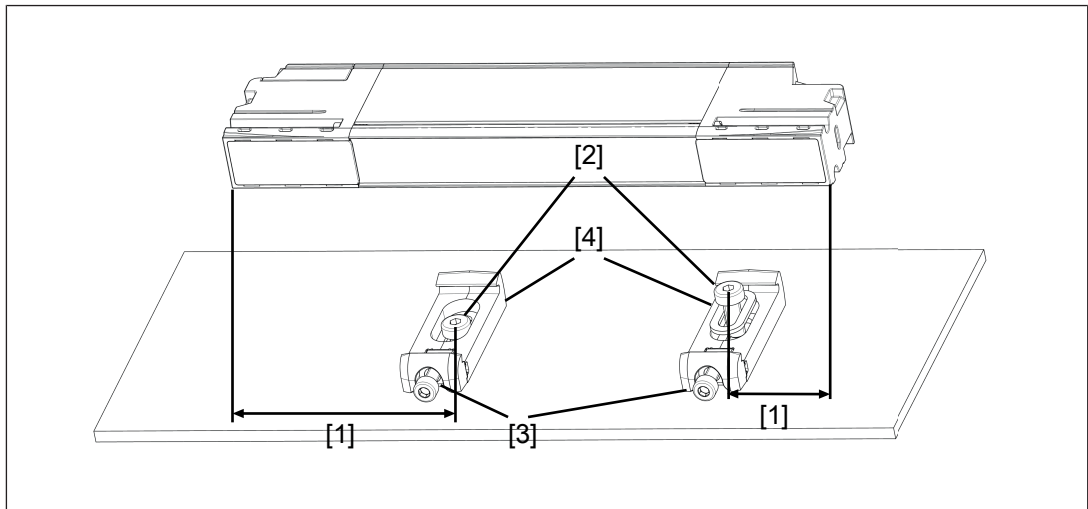

Legend

- [1] Distance from the end of the safety light grid to the position of the C-bracket = $\frac{1}{4}$ of the protected field height
- [2] M4 screw to attach the C-bracket
- [3] M3 screw to position the clamping jaw of the C-bracket
- [4] C-bracket

Attach safety light grids using O-brackets

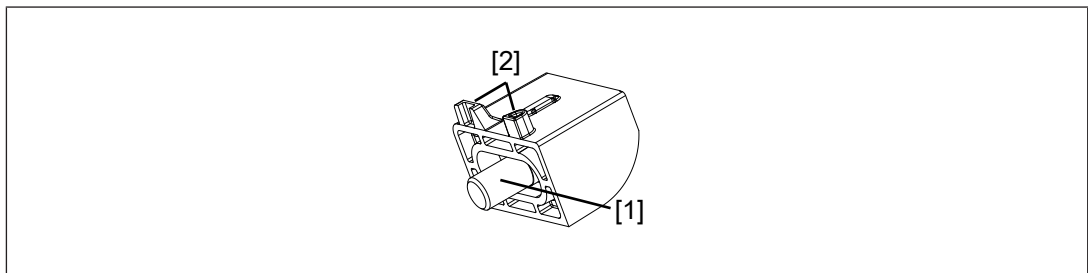

Fig.: Detailed view of the O-bracket for the connection end of the safety light grid

Legend

- [1] Fixing screw
- [2] Coding lug for the connection end of the safety light grid

For safety light grids with a protected field height over 600 mm and strong vibration we recommend that you use C-brackets or L-brackets.

1. Make two drill holes in the mounting surface [1], at a distance [5] as stated in the table.
2. Install the two O-brackets [3] and [4] in the correct position and fasten both O-brackets using the M4 screws.
3. Place the transmitter/receiver between the two O-brackets. The ends of the safety light grid must lock into position in the O-brackets.
4. Tighten the M4 screws to 1,2 Nm.

Protected field height	Distance of holes for attaching the O-brackets
150	162.2
210	222.1
270	282.0
300	312.0
330	341.9
360	371.9
390	401.7
420	431.7
450	461.7
480	491.6
510	521.6
540	551.5
570	581.5
600	611.5

Protected field heights and appropriate axis distances for O-brackets

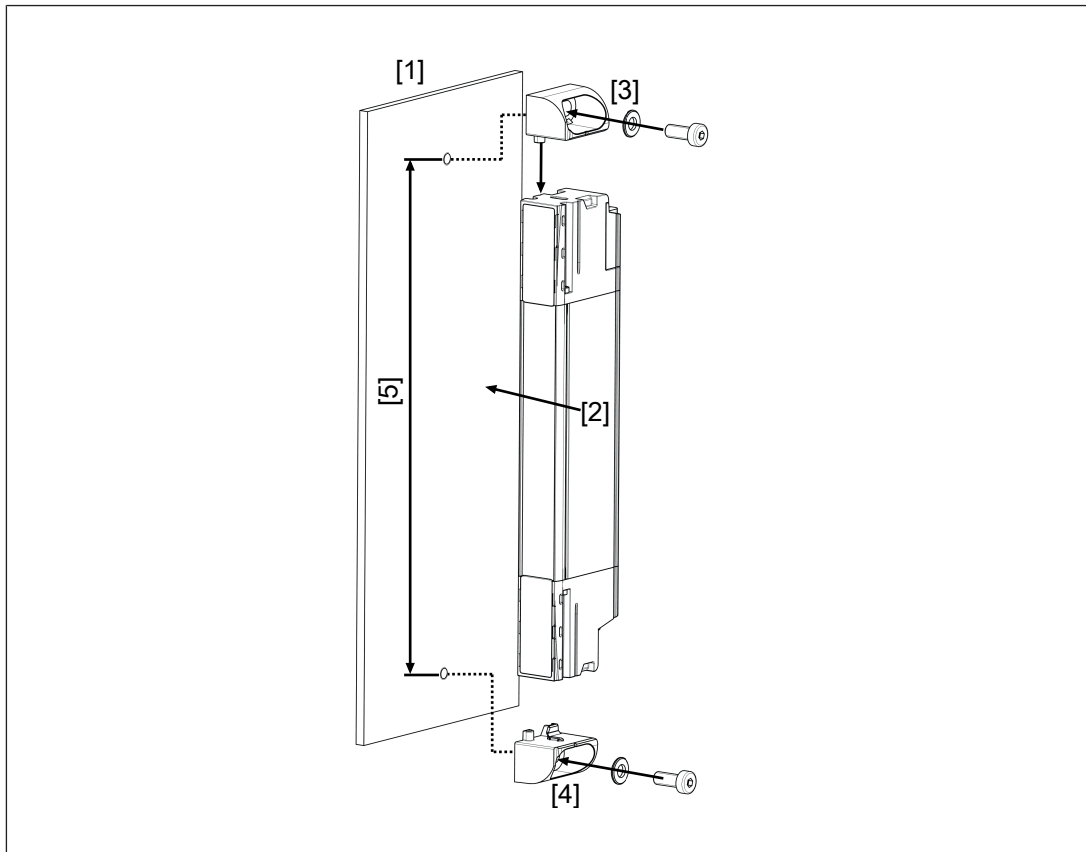
**Legend**

- [1] Mounting surface
- [2] PSEN op4H-SL Series
- [3] O-bracket – Non-connection end of safety light grid
- [4] O-bracket – Connection end of safety light grid
- [5] Distance between the holes for attaching the O-brackets to the mounting surface

Attach safety light grids using L-brackets

Detailed view of the L-bracket, non-connection end

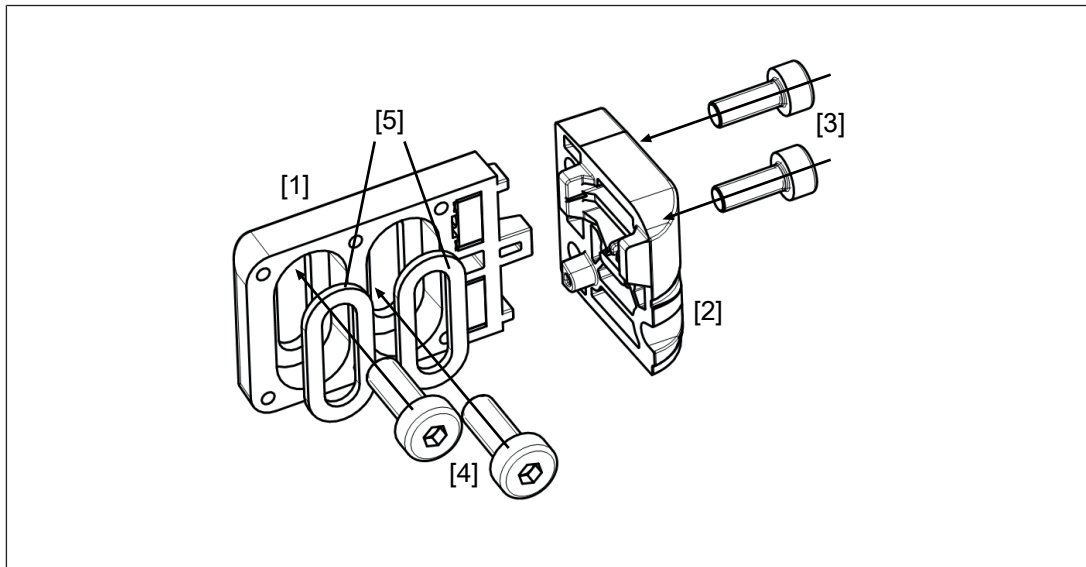

Legend

- [1] Vertical section of L-bracket
- [2] Horizontal section of L-bracket
- [3] M3 screw to attach the horizontal section of the L-bracket to the vertical section
- [4] M4 screw to attach the vertical section of the C-bracket
- [5] Slotted hole washers

1. Make two drill holes [1] in the mounting surface per L-bracket, at a distance corresponding to the length of the safety light grid [2].
2. Attach the vertical section of both L-brackets [3]. Tighten the M4 screws to 1,2 Nm.
3. Attach the horizontal section of the L-bracket at the non-connection end to the M3 screws on the vertical section [4].
4. Clamp the transmitter/receiver into the L-Bracket at the non-connection end. [5]
5. Attach the vertical section of the L-bracket at the connection end using the M3 screws [6].
6. Tighten the M3 screws on the vertical sections of both L-brackets to 1,2 Nm.

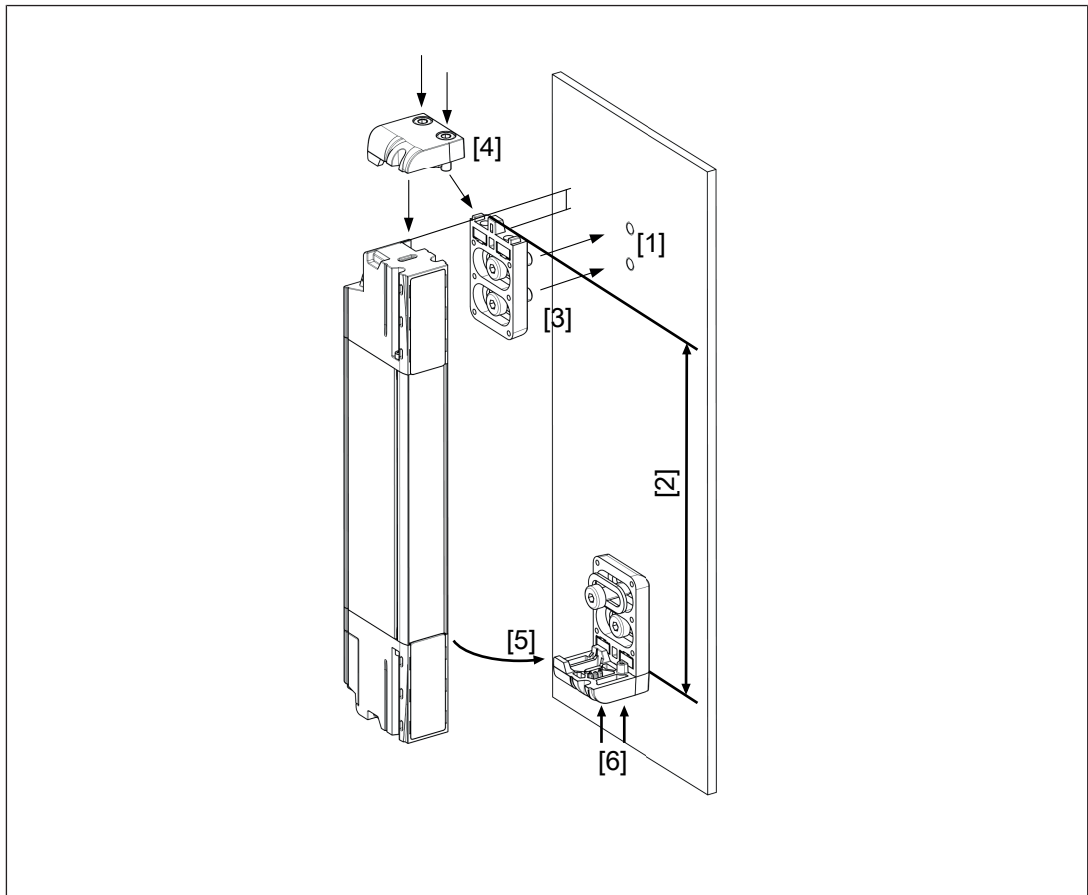
**Legend**

- [1] Drill holes in the mounting surface
- [2] Distance between the drill holes = Height of the safety light grid (see [Technical details](#)  43)
- [3] Vertical section of L-bracket
- [4] Horizontal section of L-bracket
- [5] Clamp the transmitter/receiver into the L-bracket at the connection end
- [6] Attach the horizontal section of the L-bracket to the vertical section using M3 screws

Attach safety light grids using L and C-brackets

Detailed view of the L-bracket, non-connection end

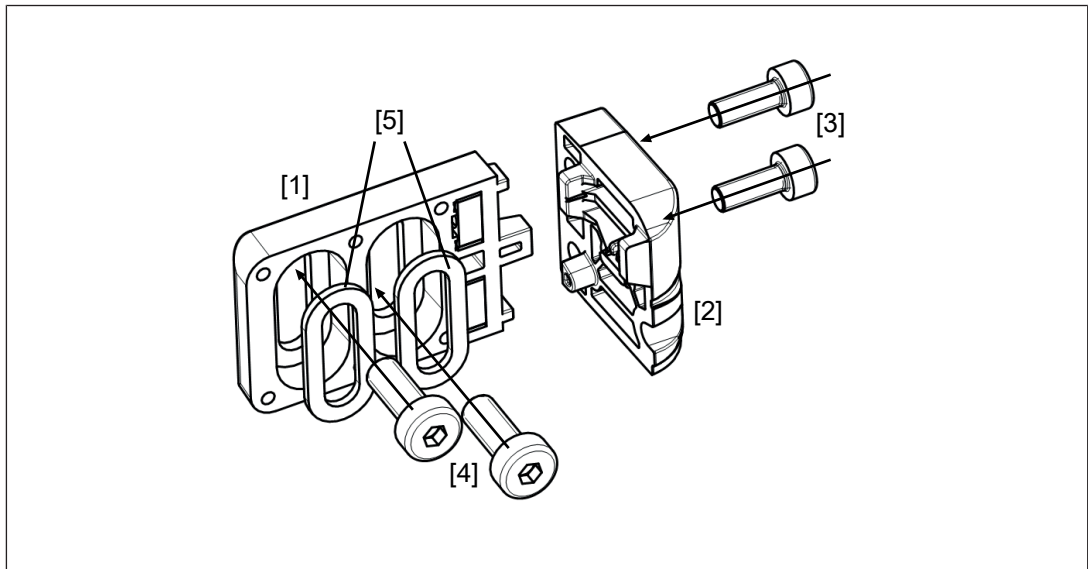

Legend

- [1] Vertical section of L-bracket
- [2] Horizontal section of L-bracket
- [3] M3 screw to attach the horizontal section of the L-bracket to the vertical section
- [4] M4 screw to attach the vertical section of the C-bracket
- [5] Slotted hole washers

1. Make two drill holes in the mounting surface for the L-bracket at the connection end as shown [1] and install the vertical section and horizontal section of the L-bracket [2]. Tighten all screws to 1,2 Nm.
2. Make two drill holes in the mounting surface as shown [1] and install the C-bracket [2]. Tighten the M4 screws to 1,2 Nm.
3. Slightly loosen the M3 screw [3] on the C-bracket and open the C bracket's clamping jaws.
4. At a slight angle, insert the transmitter/receiver into the C-bracket [4]. Use the corresponding longitudinal slot on the profile.
5. Turn the transmitter/receiver until you reach the anchor of the upper jaw [5].
6. Insert the transmitter/receiver into the L-bracket as far as it will go.
7. Tighten the M3 screw on the C-bracket to 1,2 Nm. [6]

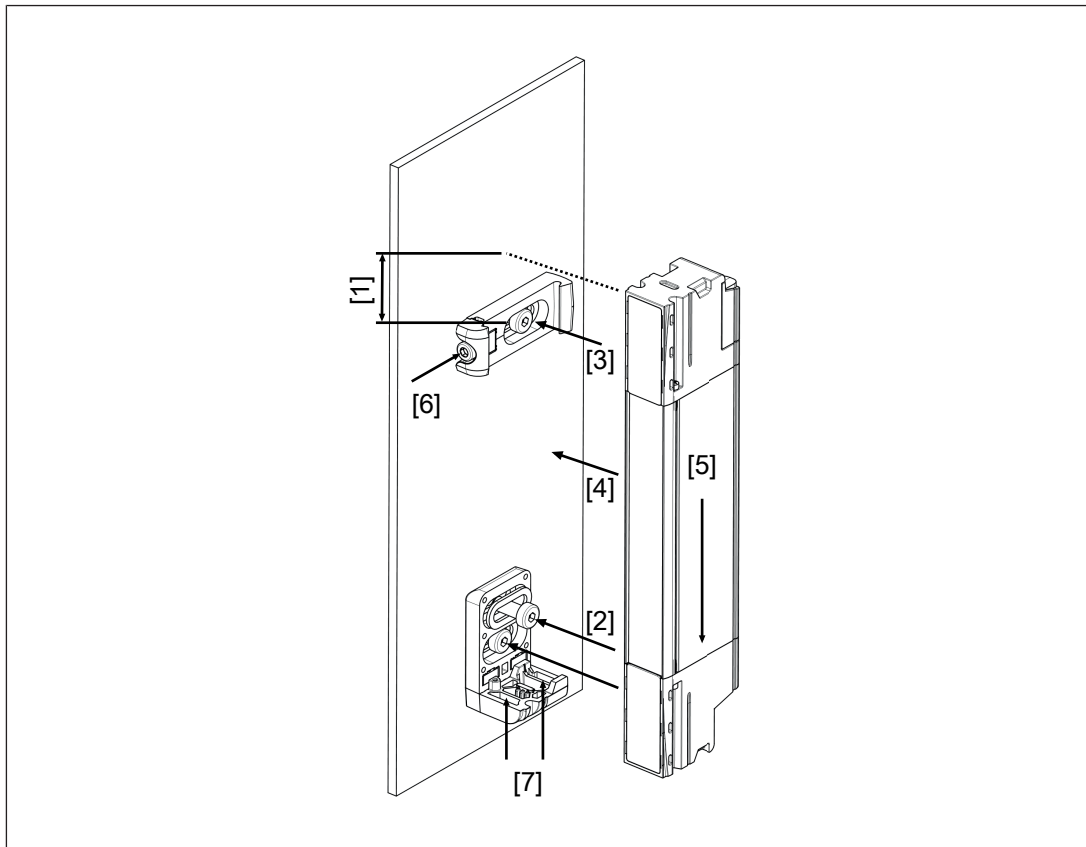

Legend

- [1] Distance from the non-connection end of the safety light grid to the position of the C-bracket at the non-connection end = $\frac{1}{4}$ of the protected field height
- [2] 2 M4 screws to attach the L-bracket
- [3] M4 screw to attach the C-bracket
- [4] Position the safety light grid in the C-bracket at a slight angle
- [5] Push the safety light grid in the L-bracket as far as it will go
- [6] M3 screw to position the clamping jaw of the C-bracket
- [7] Attach the horizontal section of the L-bracket to the vertical section using M3 screws

Cascaded safety light grid

Transmitters and receivers on cascaded safety light grids are correctly aligned in exactly the same way as a single safety light grid is aligned.

Start the alignment with the master unit and then continue with the slave unit (when there are two slave units, start with the first slave unit and then the second slave unit).

Wiring

General guidelines

- ▶ Do not lay the connecting cable near or in contact with cables that carry high or highly volatile currents.

- ▶ Use separate cables to connect the wires to the OSSDs on different safety light grids or safety switches.
- ▶ For supply voltage, use only PELV/SELV power supplies that have a voltage buffer in accordance with EN 60204-1.
- ▶ The power supply must be able to bridge a short (20 ms) supply voltage failure in accordance with EN 61496-1.
- ▶ The protection type (see [Technical details \[43\]](#)) can only be achieved by using the Pilz connection leads available as an accessory.
- ▶ Connection to evaluation devices
 - Use the cables listed in the order reference (see [Order references for accessories \[51\]](#))
 - The clamps for connection to the evaluation device must be kept in a locked control cabinet. This prevents unauthorised modifications.
- ▶ Ensure compliance with permissible cable bending radii (see [Technical details \[43\]](#)).

Connector pin assignment

Transmitter and receiver electrical connections are made with M12 connectors. These connectors are located on the bottom of the transmitters and receivers.

- ▶ Ensure that the wiring has been performed as indicated.

5-pin connector on the transmitter	PIN	Assignment	Cable colour
	1	+24 VDC	brown
	2	Restart Configuration of the type of restart or activation of alignment mode	white
	3	0 VDC	blue
	4	Reserved	black
	5	Start button	grey

5-pin connector on the receiver	PIN	Assignment	Cable colour
	1	+24 VDC	brown
	2	OSSD 1	white
	3	0 VDC	blue
	4	OSSD 2	black
	5	EDM Activation/deactivation of EDM function	grey

Wiring for activation of alignment mode

5-pin connector on the transmitter	PIN	Assignment	Cable colour
	1	+24 VDC	brown
	3	0 VDC	blue
	2	Leave Pin 2 unconnected	2
	5	Start button	grey
	4	Reserved	black

Wiring for manual restart

5-pin connector on the transmitter	PIN	Assignment	Cable colour
	1	+24 VDC	brown
	3	0 VDC	blue
	2	Leave Pin 2 unconnected	white
	5	Connect start button to 24 VDC via N/C contact	grey
	4	Reserved	black

Wiring for automatic restart

5-pin connector on the transmitter	PIN	Assignment	Cable colour
	1	+24 VDC	brown
	3	0 VDC	blue
	2	Link Pin 2 and Pin 5	white
	5	Start button	grey
	4	Reserved	black

Wiring for EDM deactivated

5-pin connector on the receiver	PIN	Assignment	Cable colour
	1	+24 VDC	brown
	3	0 VDC	blue
	4	OSSD 2	black
	2	OSSD 1	white
	5	Link Pin 5 and Pin 2	grey

Wiring for EDM activated

5-pin connector on the receiver	PIN	Assignment	Cable colour
	1	+24 VDC	brown
	3	0 VDC	blue
	4	OSSD 2	black
	2	OSSD 1	white
	5	Pin 5 controlled via N/C contact of the positive-guided relay	grey

Earthing the safety light grid

Please note:

- ▶ Connect the 0 V connections on all the 24 V power supplies and earth the 0 V mains at a single point, or ensure that measures are in place to monitor for earth faults.
- ▶ The connection of the 0 V supply to the central earth bar or earth fault monitor must be in accordance with relevant national regulations (such as EN 60204-1, NFPA 79:17-7, NEC: Article 250).
- ▶ Connections should be protected from corrosion.
- ▶ Flexible earthing straps should be used on moving earth parts (e.g. machine parts, gates). Ensure these earthing straps are as short and wide as possible.

Cascaded safety light grid

Use the cables stated in the [Order references for accessories](#)  51].

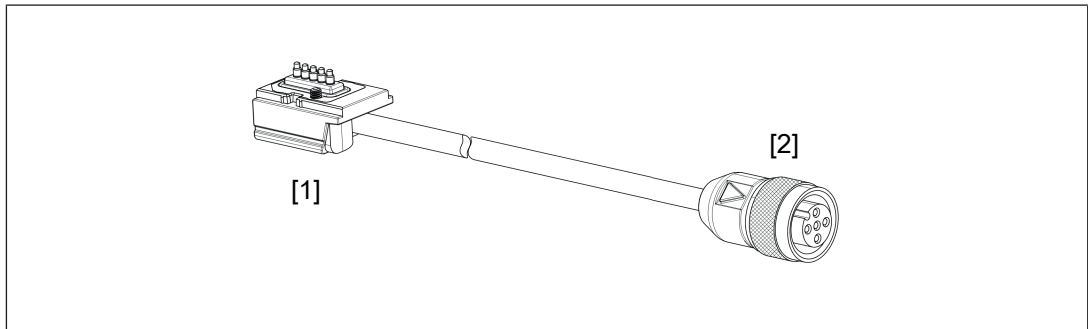

Legend

[1] Connection to master unit, cascading adapter, 5-pin

[2] Connection to slave unit, M12, 5-pin, female socket

1. Install the master unit and slave unit(s). See [Installation](#)  22].
2. Loosen the screws [1] on the cover of the cascading adapter and remove the cover.

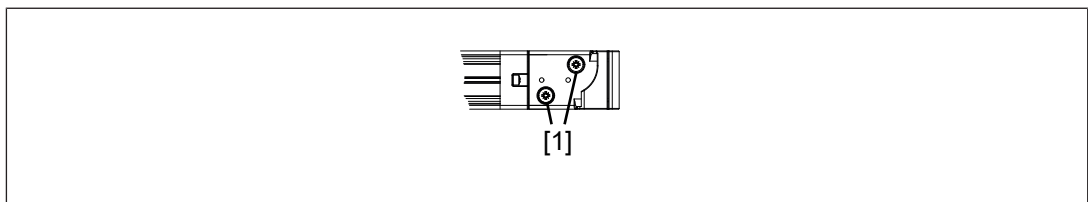

Legend

[1] Fixing screws on the cover of the cascading adapter

3. Connect the 5-pin cascading adapter on the cable PSEN op SL cascading to the cascading adapter on the master unit and the 5-pin female socket to the slave unit.
4. Re-attach the cover of the cascading adapter and tighten both screws to 0,2 Nm.

Alignment

Alignment options depend on the installation type





The options for alignment (moving horizontally or vertically, rotating, tilting) depend on the type of bracket used for fastening and on the base to which the safety light grid is fastened (strut profile or smooth surface).

Bracket	Base	
	Smooth surface (e.g. wall)	Strut profile
C-bracket	Vertical: Loosen the clamping jaws on both brackets and move within the brackets Horizontal: Remove safety light grid from bracket, loosen the brackets on the base and move within the slot	Vertical: Loosen the clamping jaws on both brackets and move within the brackets Horizontal: Move within the slot, but only before the safety light grid is mounted on the brackets
O-bracket	Vertical: Remove the safety light grid and brackets completely and drill new holes Horizontal: Loosen the brackets on the base and move within the slot	Vertical: Loosen both brackets on the profile and move within the profile Horizontal: Loosen the brackets on the profile and move within the slot
L-bracket	Vertical: Remove the safety light grid and brackets completely and drill new holes Horizontal: Remove safety light grid from bracket, loosen the brackets on the base and move within the slot	Vertical: Loosen both brackets on the profile and move within the profile Horizontal: Loosen the brackets on the profile and move within the slot

Orientation

For the safety light grid to function properly, the transmitter and receiver must be correctly aligned.

Safety light grid alignment

























1. Activate alignment mode. Pin 2 and Pin 5 on the transmitter must be unconnected (see [Connector pin assignment](#) [30]).
2. Make sure that the transmitter and receiver are at the same height.
3. Make sure that the receiver is in a stable position.
4. Use horizontal movement, vertical movement and rotation to align the transmitter so that this LED on the receiver lights up yellow: .
5. Rotate the transmitter at the connection end around the optical axis until this LED on the receiver flashes green: .
6. Restrict the area within which this LED flashes green: . By making changes to the transmitter and then the receiver. Align both units in the middle of this area, so that these two LEDs light up yellow: , .

7. Tighten the screws on the brackets with the max. torque [ 43].

- ▶ Check that the green LED on the receiver is lit.
- ▶ Check that the safety light grid operates correctly.
If a single light beam is interrupted by an opaque object
 - the green LED must go out,
 - the red LED must light and
 - the safety light grid must switch to a safe state.

▶ For this test you should use a test rod for a safety light grid with a resolution of 24 mm.

LED indicators in alignment mode

						Meaning
●	●	○	●	 red	 green	Safety light grid not aligned, no synchronisation of first and last light beams.
 yellow	●	○	●	 red	 green	Synchronisation of first and last light beams. One or more light beams are interrupted.
 yellow	 yellow	○	●	 green	 green	Synchronisation of first and last light beams. Weak signal strength. Protected field is clear.
 yellow	 yellow	○	●	 green	 green	Synchronisation of first and last light beams. Medium signal strength. Protected field is clear.
 yellow	 yellow	○	 yellow	 green	 green	Synchronisation of first and last light beams. Medium signal strength. Protected field is clear.

Commissioning

System connection

Make sure that the selected evaluation device has the following properties:

- ▶ 2-channel with feasibility monitoring
- ▶ OSSD signals are evaluated

Suitable Pilz evaluation devices are, for example:

- ▶ PNOZelog for monitoring safety light grids
- ▶ PNOZsigma for monitoring safety light grids
- ▶ PNOZ X for monitoring safety light grids

- ▶ PNOZmulti for safety light grid monitoring
Configure the safety light grid in the PNOZmulti Configurator with switch type 3.
- ▶ Automation system PSS 4000 for monitoring safety light grids with the FS_LightCurtain function block

The correct connection to the respective evaluation device is described in the operating manual for the evaluation device. Connect the evaluation device according to the specifications in the selected evaluation device's operating manual.

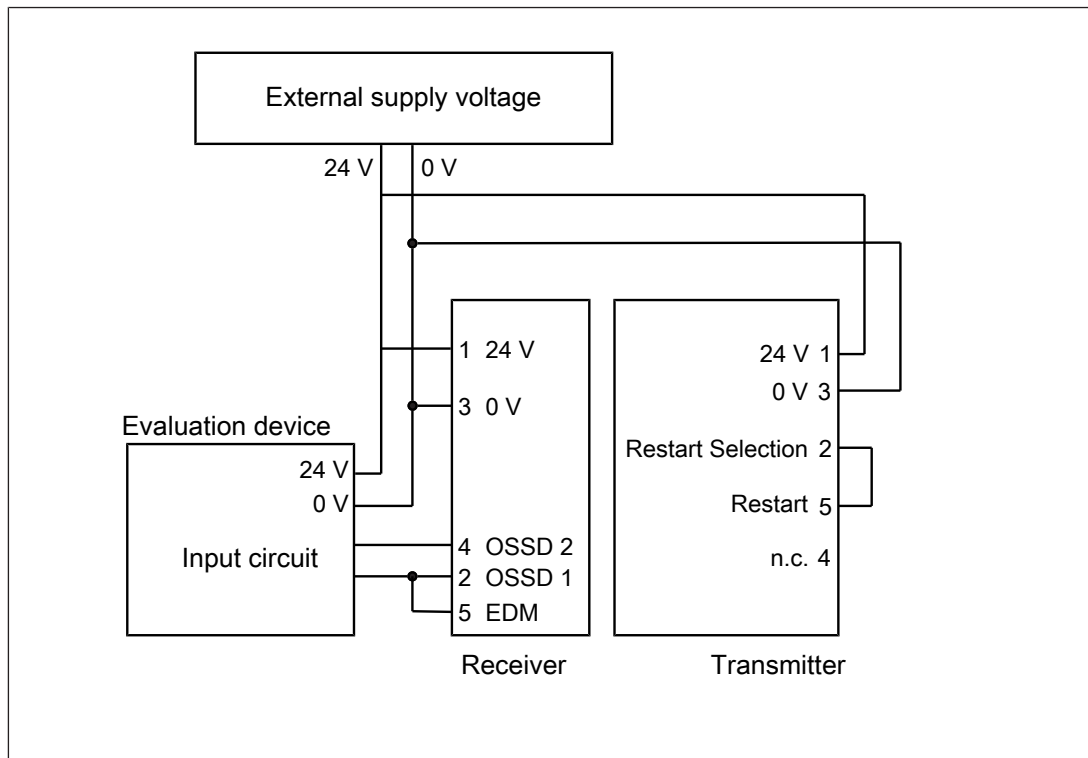

Fig.: Dual-channel connection of the safety light grid on the input circuit of an evaluation device – EDM deactivated, automatic restart

Checking the safety light grid

Once the safety light grid has been installed and aligned, final inspections must be carried out before it can be put into service.



INFORMATION

This inspection may only be carried out by qualified personnel.

Check the safety function of the safety light grid

Procedure

In each of the stated tests, the OSSDs must switch to the OFF state and the OSSD status LED on the receiver must light up red: .

1. Move the test rod slowly through the protected field (see diagram):
 - In the vicinity of the transmitter
 - In the vicinity of the receiver
 - In the centre of the protected field
2. Place the test rod at rest in a position in the protected field that is considered critical for the safety assessment results

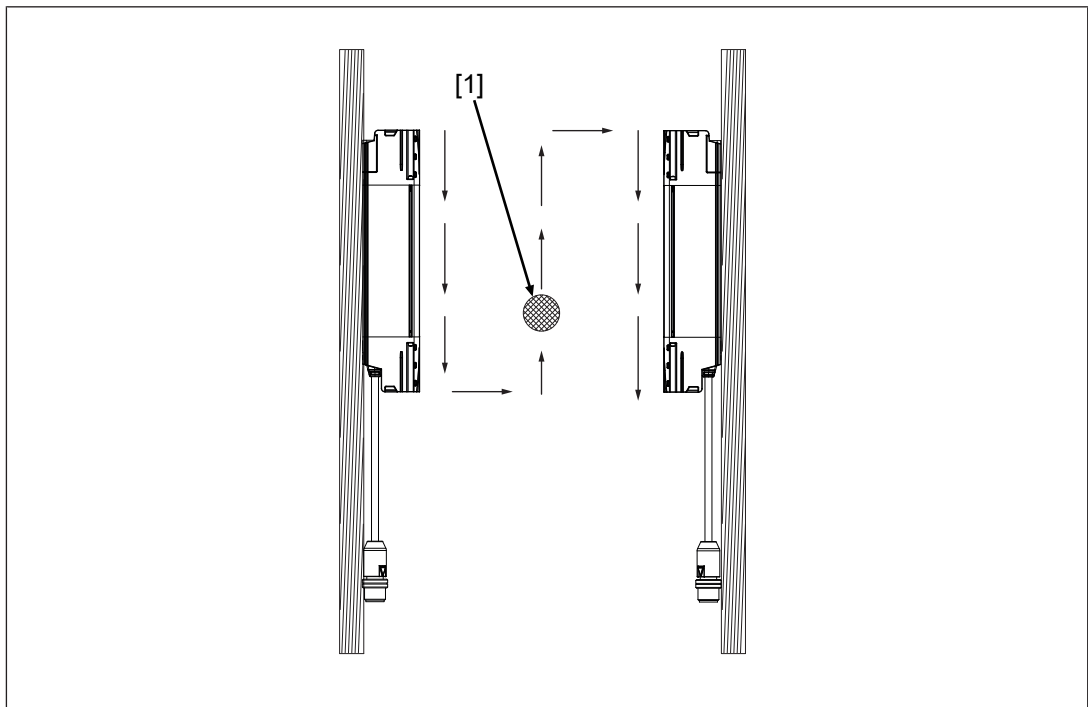

Legend

[1] Test rod

Check ambient conditions and installation

- ▶ Correct alignment and attachment
Check the seating of the mounting screws by applying pressure to the edges of the safety light grid. The OSSD LED  on the receiver must not light up red.
- ▶ Safety distance
The safety distance must comply with the requirements in Maintaining the safety distance.
- ▶ Circumventing the protected field
The danger zone must be secured so that it is impossible to access by circumventing the protected field.

- ▶ Protected field perimeters
The protected field perimeters (see [Dimensions \[42\]](#)) must completely secure the hazardous area, making it inaccessible.
- ▶ Response and stopping times must fulfil the requirements in Maintaining the safety distance
Ensure that the safety light grid's response time and the machine's stopping time fulfil the requirements in Maintaining the safety distance.
- ▶ No intense or flashing light sources in the vicinity
There may be no especially intense or flashing light sources in the vicinity of the safety light grid.
- ▶ Ambient conditions
Please observe the [environmental conditions \[14\]](#).

Operation

Display elements



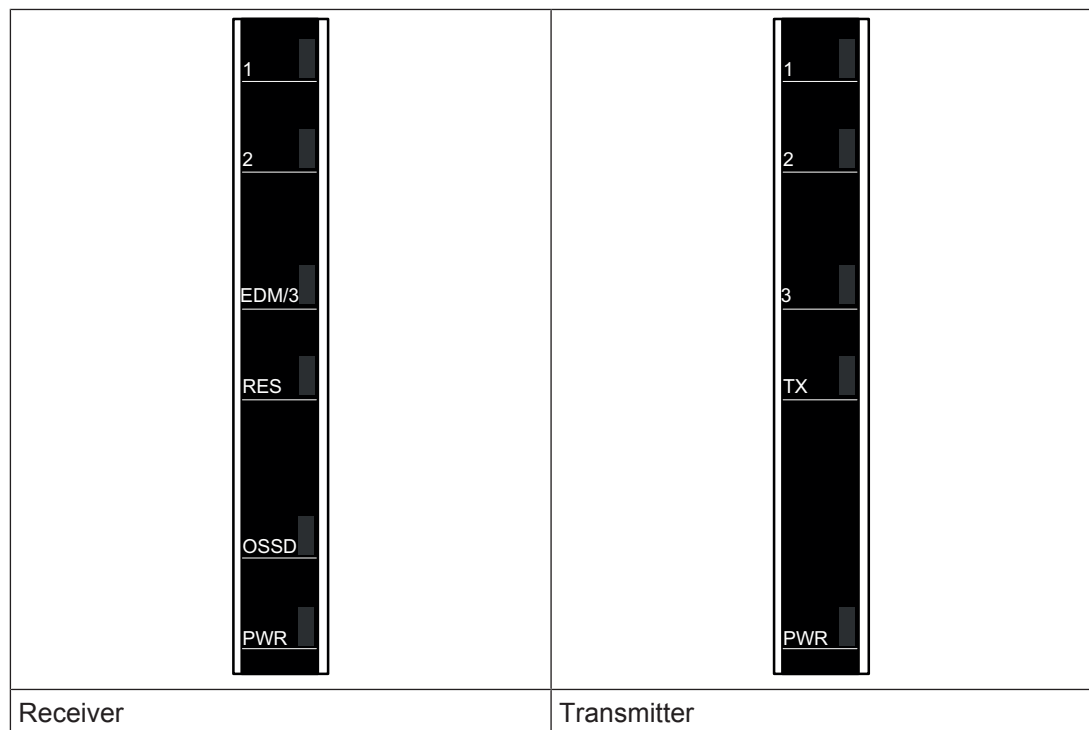

The safety light grid's operating status is indicated with LEDs at the connection ends of the receiver and transmitter.

- ▶ 6 LEDs on the receiver for support with alignment, error display and operating status
- ▶ 5 LEDs on the transmitter for displaying errors and operating status



































































Status information

Legend

















-  LED on
-  LED flashes
-  LED off
-  Display has no significance

Receiver

						Meaning
				 green	 green	Ready for operation
				 red	 green	Protected field is interrupted.
		 yel- low		 red	 green	Protected field is interrupted. EDM is activated.
 yel- low				 red	 green	Internal error. Switch the safety light grid off and then on again. If the error persists, please contact Pilz.
	 yel- low			 red	 green	Error in the synchronisation of the light beams. Check the ambient conditions and the wiring. Switch the safety light grid off and then on again.
		 yel- low		 red	 green	EDM error. Check the wiring of the connected relay. Switch the safety light grid off and then on again.
 yel- low	 yel- low			 red	 green	Error in cascading. Check the cascading and the wiring for the cascading.
 yel- low		 yel- low		 red	 green	Error in restart function. Check the ambient conditions and the wiring for the start button. Switch the safety light grid off and then on again.

						Meaning
●	 yellow	 yellow	●	 red	 green	<p>Error in OSSDs.</p> <p>Check the ambient conditions and the wiring.</p> <p>Switch the safety light grid off and then on again.</p>
●	●	●	●	●	●	<p>Supply voltage error.</p> <p>Ensure that the supply voltage corresponds to the information in the Technical details [ 43].</p>

Transmitter

					Meaning
●	●	●	 yellow	 green	Ready for operation
 yellow	●	●	●	 green	<p>Internal error.</p> <p>Check the ambient conditions and the wiring.</p> <p>Switch the safety light grid off and then on again.</p>
●	 yellow	●	●	 green	<p>Error in the synchronisation of the light beams.</p> <p>Check the ambient conditions and the wiring.</p> <p>Switch the safety light grid off and then on again.</p>
 yellow	 yellow	●	●	 green	<p>Error in cascading.</p> <p>Check the cascading and the wiring for the cascading.</p>
 yellow	●	 yellow	●	 green	<p>Error in restart function.</p> <p>Check the ambient conditions and the wiring for the start button.</p> <p>Switch the safety light grid off and then on again.</p>

Safety light grid restart

⇒ Disconnect the supply voltage from the safety light grid and reconnect it. The [automatic restart](#) [ 11] begins.

Malfunction



DANGER!

Loss of safety function due to a malfunction of the safety light grid

A safety light grid malfunction may lead to serious injury or death.

If there is a safety light grid malfunction, immediately discontinue operation of the system components whose hazardous area the grid secures.



Regular checks and maintenance

Checks

Regular checks can bring to light changes to the plant/machine, safeguards and ambient conditions.

Regular check

Pilz recommends that the safety light grid be checked every six months.

- ▶ Check the safety light grid's front panel.
 - Scratched front panel: Replace the safety light grid.
 - Dirty front panel: [Clean the front panel](#)  42].
In a particularly dirty environment, front panel cleanliness should be checked more frequently.
- ▶ Check the tightness of the safety light grid's front panel.
All screws must be tightened to the torque specified in the [Technical details](#)  43].
- ▶ Check the safety function of the safety light grid (see [Check the safety function of the safety light grid](#)  37]).

Check after plant/machine modification

Check the safety light grid each time the plant/machine is modified. Changing the safety light grid or swapping safety light grid components should be regarded as a modification. The requirements of the applicable national regulations must be observed **absolutely**.



INFORMATION

This inspection may only be carried out by qualified personnel.

The Appendix contains a [Checklist](#)  51] which should help you perform the safety check.

Maintenance

Other than cleaning the lens covers, the safety light grids requires no other form of maintenance.



CAUTION!

Improper cleaning agents can damage the safety light grid and lead to malfunctions

Moist cotton cloths should be used for cleaning.

Avoid using

- ▶ Alcohol,
- ▶ Solvents,
- ▶ Cloths made of wool,
- ▶ Cloths made of synthetic material.

Clean the lens covers during the regular [check of the safety light grid](#)  41].

Dimensions

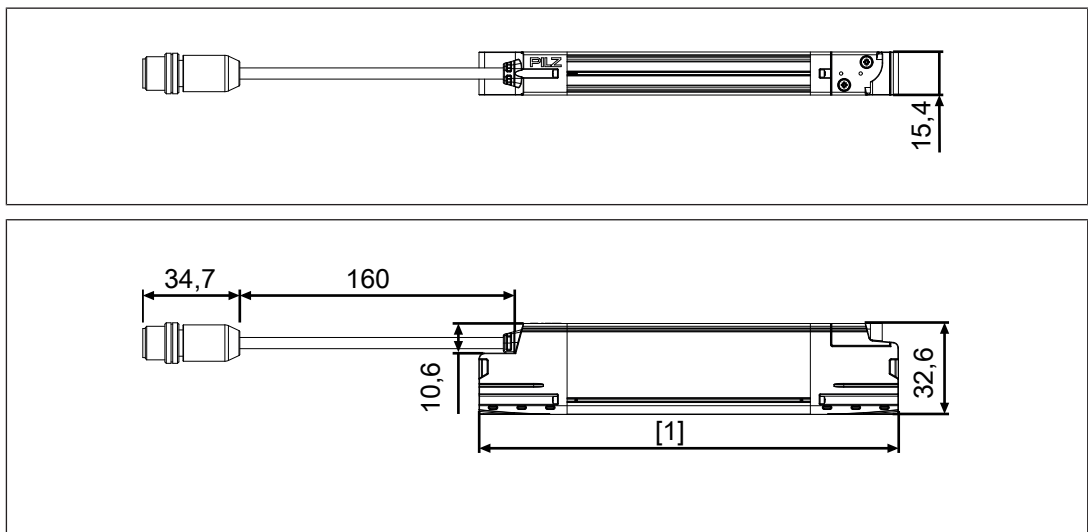

Legend

[1] Protected field height

Technical details Order no. 631120-631122

General	631120	631121	631122
Approvals	CE, TÜV, cULus Listed	CE, TÜV, cULus Listed	CE, TÜV, cULus Listed
ESPE type	4	4	4
Sensor's mode of operation	Optical	Optical	Optical
Height of protected field	150 mm	300 mm	450 mm
Resolution			
Protection type	Hand	Hand	Hand
Operating range	0,2 - 6 m	0,2 - 6 m	0,2 - 6 m
Detection capability	24 mm	24 mm	24 mm
Electrical data	631120	631121	631122
Supply voltage			
Voltage	24 V	24 V	24 V
Kind	DC	DC	DC
Voltage tolerance	-20 %/+20 %	-20 %/+20 %	-20 %/+20 %
Max. power consumption receiver	4,2 W	4,2 W	4,2 W
Max. power consumption transmitter	1,6 W	1,6 W	1,6 W
Protection class	3	3	3
Optical data	631120	631121	631122
Opening angle	-2,5 - 2,5 deg	-2,5 - 2,5 deg	-2,5 - 2,5 deg
Used wavelength range	850 nm	850 nm	850 nm
Semiconductor outputs	631120	631121	631122
OSSD safety outputs	2	2	2
Switching current per output	500 mA	500 mA	500 mA
Times	631120	631121	631122
Supply interruption before de-energisation	0 ms	0 ms	0 ms
Response time t1	7 ms	8 ms	9 ms
Max. response time with cascading	20 ms	20 ms	20 ms
Environmental data	631120	631121	631122
Ambient temperature			
Temperature range	0 - 55 °C	0 - 55 °C	0 - 55 °C
Storage temperature			
Temperature range	-25 - 70 °C	-25 - 70 °C	-25 - 70 °C
Climatic suitability			
Humidity	15 ... 95 %	15 ... 95 %	15 ... 95 %
Condensation during operation	Not permitted	Not permitted	Not permitted

Environmental data	631120	631121	631122
Vibration			
In accordance with the standard	EN 60068-2-6	EN 60068-2-6	EN 60068-2-6
Frequency	10 - 55 Hz	10 - 55 Hz	10 - 55 Hz
Amplitude	0,35 mm	0,35 mm	0,35 mm
Shock stress			
In accordance with the standard	EN 60068-2-29	EN 60068-2-29	EN 60068-2-29
Number of shocks	1000	1000	1000
Acceleration	10g	10g	10g
Duration	16 ms	16 ms	16 ms
Protection type			
In accordance with the standard	EN 60529	EN 60529	EN 60529
Housing	IP65	IP65	IP65
Mechanical data	631120	631121	631122
Cable length L1	0,2 m	0,2 m	0,2 m
Min. bending radius (fixed permanently) K1	1 x Ø	1 x Ø	1 x Ø
Min. bending radius (fixed permanently) cascading cable	1 x Ø	1 x Ø	1 x Ø
Cable insulation material K1	PVC	PVC	PVC
Connection type			
Receiver	M12, 5-pin male connector	M12, 5-pin male connector	M12, 5-pin male connector
Transmitter	M12, 5-pin male connector	M12, 5-pin male connector	M12, 5-pin male connector
Max. cable length	20 m	20 m	20 m
Material			
Top	Aluminium	Aluminium	Aluminium
End caps	Zamak	Zamak	Zamak
Front screen	PMMA	PMMA	PMMA
Max. torque setting			
Fixing screw	1,2 Nm	1,2 Nm	1,2 Nm
Cover for cascading adapter	0,2 Nm	0,2 Nm	0,2 Nm
Dimensions			
Height	150 mm	300 mm	450 mm
Width	15,4 mm	15,4 mm	15,4 mm
Depth	32,6 mm	32,6 mm	32,6 mm
Weight	300 g	500 g	650 g

Technical details Order no. 631123-631125

General	631123	631124	631125
Approvals	CE, TÜV, cULus Listed	CE, TÜV, cULus Listed	CE, TÜV, cULus Listed
ESPE type	4	4	4
Sensor's mode of operation	Optical	Optical	Optical
Height of protected field	600 mm	750 mm	900 mm
Resolution			
Protection type	Hand	Hand	Hand
Operating range	0,2 - 6 m	0,2 - 6 m	0,2 - 6 m
Detection capability	24 mm	24 mm	24 mm
Electrical data	631123	631124	631125
Supply voltage			
Voltage	24 V	24 V	24 V
Kind	DC	DC	DC
Voltage tolerance	-20 %/+20 %	-20 %/+20 %	-20 %/+20 %
Max. power consumption receiver	4,2 W	4,2 W	4,2 W
Max. power consumption transmitter	1,6 W	1,6 W	1,6 W
Protection class	3	3	3
Optical data	631123	631124	631125
Opening angle	-2,5 - 2,5 deg	-2,5 - 2,5 deg	-2,5 - 2,5 deg
Used wavelength range	850 nm	850 nm	850 nm
Semiconductor outputs	631123	631124	631125
OSSD safety outputs	2	2	2
Switching current per output	500 mA	500 mA	500 mA
Times	631123	631124	631125
Supply interruption before de-energisation	0 ms	0 ms	0 ms
Response time t1	9 ms	10 ms	11 ms
Max. response time with cascading	20 ms	20 ms	20 ms
Environmental data	631123	631124	631125
Ambient temperature			
Temperature range	0 - 55 °C	0 - 55 °C	0 - 55 °C
Storage temperature			
Temperature range	-25 - 70 °C	-25 - 70 °C	-25 - 70 °C
Climatic suitability			
Humidity	15 ... 95 %	15 ... 95 %	15 ... 95 %
Condensation during operation	Not permitted	Not permitted	Not permitted

Environmental data	631123	631124	631125
Vibration			
In accordance with the standard	EN 60068-2-6	EN 60068-2-6	EN 60068-2-6
Frequency	10 - 55 Hz	10 - 55 Hz	10 - 55 Hz
Amplitude	0,35 mm	0,35 mm	0,35 mm
Shock stress			
In accordance with the standard	EN 60068-2-29	EN 60068-2-29	EN 60068-2-29
Number of shocks	1000	1000	1000
Acceleration	10g	10g	10g
Duration	16 ms	16 ms	16 ms
Protection type			
In accordance with the standard	EN 60529	EN 60529	EN 60529
Housing	IP65	IP65	IP65
Mechanical data	631123	631124	631125
Cable length L1	0,2 m	0,2 m	0,2 m
Min. bending radius (fixed permanently) K1	1 x Ø	1 x Ø	1 x Ø
Min. bending radius (fixed permanently) cascading cable	1 x Ø	1 x Ø	1 x Ø
Cable insulation material K1	PVC	PVC	PVC
Connection type			
Receiver	M12, 5-pin male connector	M12, 5-pin male connector	M12, 5-pin male connector
Transmitter	M12, 5-pin male connector	M12, 5-pin male connector	M12, 5-pin male connector
Max. cable length	20 m	20 m	20 m
Material			
Top	Aluminium	Aluminium	Aluminium
End caps	Zamak	Zamak	Zamak
Front screen	PMMA	PMMA	PMMA
Max. torque setting			
Fixing screw	1,2 Nm	1,2 Nm	1,2 Nm
Cover for cascading adapter	0,2 Nm	0,2 Nm	0,2 Nm
Dimensions			
Height	600 mm	750 mm	900 mm
Width	15,4 mm	15,4 mm	15,4 mm
Depth	32,6 mm	32,6 mm	32,6 mm
Weight	750 g	900 g	1.100 g

Technical details Order no. 631126-631127

General	631126	631127
Approvals	CE, TÜV, cULus Listed	CE, TÜV, cULus Listed
ESPE type	4	4
Sensor's mode of operation	Optical	Optical
Height of protected field	1.050 mm	1.200 mm
Resolution		
Protection type	Hand	Hand
Operating range	0,2 - 6 m	0,2 - 6 m
Detection capability	24 mm	24 mm
Electrical data	631126	631127
Supply voltage		
Voltage	24 V	24 V
Kind	DC	DC
Voltage tolerance	-20 %/+20 %	-20 %/+20 %
Max. power consumption receiver	4,2 W	4,2 W
Max. power consumption transmitter	1,6 W	1,6 W
Protection class	3	3
Optical data	631126	631127
Opening angle	-2,5 - 2,5 deg	-2,5 - 2,5 deg
Used wavelength range	850 nm	850 nm
Semiconductor outputs	631126	631127
OSSD safety outputs	2	2
Switching current per output	500 mA	500 mA
Times	631126	631127
Supply interruption before de-energisation	0 ms	0 ms
Response time t1	12 ms	13 ms
Max. response time with cascading	20 ms	20 ms
Environmental data	631126	631127
Ambient temperature		
Temperature range	0 - 55 °C	0 - 55 °C
Storage temperature		
Temperature range	-25 - 70 °C	-25 - 70 °C
Climatic suitability		
Humidity	15 ... 95 %	15 ... 95 %
Condensation during operation	Not permitted	Not permitted
Vibration		
In accordance with the standard	EN 60068-2-6	EN 60068-2-6
Frequency	10 - 55 Hz	10 - 55 Hz
Amplitude	0,35 mm	0,35 mm

Environmental data	631126	631127
Shock stress		
In accordance with the standard	EN 60068-2-29	EN 60068-2-29
Number of shocks	1000	1000
Acceleration	10g	10g
Duration	16 ms	16 ms
Protection type		
In accordance with the standard	EN 60529	EN 60529
Housing	IP65	IP65
Mechanical data	631126	631127
Cable length L1	0,2 m	0,2 m
Min. bending radius (fixed permanently) K1	1 x Ø	1 x Ø
Min. bending radius (fixed permanently) cascading cable	1 x Ø	1 x Ø
Cable insulation material K1	PVC	PVC
Connection type		
Receiver	M12, 5-pin male connector	M12, 5-pin male connector
Transmitter	M12, 5-pin male connector	M12, 5-pin male connector
Max. cable length	20 m	20 m
Material		
Top	Aluminium	Aluminium
End caps	Zamak	Zamak
Front screen	PMMA	PMMA
Max. torque setting		
Fixing screw	1,2 Nm	1,2 Nm
Cover for cascading adapter	0,2 Nm	0,2 Nm
Dimensions		
Height	1.050 mm	1.200 mm
Width	15,4 mm	15,4 mm
Depth	32,6 mm	32,6 mm
Weight	1.250 g	1.400 g

Safety characteristic data



NOTICE

You must comply with the safety-related characteristic data in order to achieve the required safety level for your plant/machine.

Operating Mode	EN ISO 13849-1: 2015 PL	EN ISO 13849-1: 2015 Category	EN 62061 SIL CL	EN 62061 PFH _D [1/h]	IEC 61511 SIL	IEC 61511 PFD	EN ISO 13849-1: 2015 T _M [year]
2-ch. OSSD	PL e	Cat. 4	SIL CL 3	7,89E-09	–	–	20

All the units used within a safety function must be considered when calculating the safety characteristic data.



INFORMATION

A safety function's SIL/PL values are **not** identical to the SIL/PL values of the units that are used and may be different. We recommend that you use the PAScal software tool to calculate the safety function's SIL/PL values.

Order reference

Safety light grid

Product type	Features	Order no.
PSEN op4H-SL-24-015/1	Safety light grid for hand protection, protected field height of 150 mm	631 120
PSEN op4H-SL-24-030/1	Safety light grid for hand protection, protected field height of 300 mm	631 121
PSEN op4H-SL-24-045/1	Safety light grid for hand protection, protected field height of 450 mm	631 122
PSEN op4H-SL-24-060/1	Safety light grid for hand protection, protected field height of 600 mm	631 123
PSEN op4H-SL-24-075/1	Safety light grid for hand protection, protected field height of 750 mm	631 124
PSEN op4H-SL-24-090/1	Safety light grid for hand protection, protected field height of 900 mm	631 125
PSEN op4H-SL-24-105/1	Safety light grid for hand protection, protected field height of 1050 mm	631 126
PSEN op4H-SL-24-120/1	Safety light grid for hand protection, protected field height of 1200 mm	631 127

Accessories

Installation materials

Product type	Features	Order no.
PSEN op SL Bracket C	Mounting bracket for safety light grid PSEN op SL, Bracket C for lateral mounting on the profile	631 180
PSEN op SL Bracket L	Mounting bracket for safety light grid PSEN op SL, Bracket L for mounting where there is strong vibration	631 181
PSEN op SL Bracket O	Mounting bracket for safety light grid PSEN op SL, Bracket O for minimum installation width	631 182

Cable

Product type	Connection 1	Connection 2	Length	Order No.
PSEN op cable M12-5sf	unshielded, straight, M12, 5-pin, socket	Open cable	3 m	630 310
			5 m	630 311
			10 m	630 312
			20 m	630 298

Cascading

Product type	Connection 1	Connection 2	Length	Order No.
PSEN op SL cascading	M12, 5-pin, socket	5-pin, cascading adapter	0.1 m	631 183
			0.5 m	631 184
			1 m	631 185

Test object

Product type	Features	Order no.
PSEN op Testpiece F 24m	Test rod for safety light grid with finger protection, \varnothing 24 mm	631 186

Deviating mirror

Product type	Features	Order no.
PSEN op Mirror-060/1	Deviating mirror, width 89 mm, height 545 mm for safety light grid with protected field height up to 420 mm	630 901
PSEN op Mirror-090/1	Deviating mirror, width 89 mm, height 845 mm for safety light grid with protected field height up to 720 mm	630 902
PSEN op Mirror-120/1	Deviating mirror, width 89 mm, height 1145 mm for safety light grid with protected field height up to 1020 mm	630 903
PSEN op Mirror-165/1	Deviating mirror, width 89 mm, height 1595 mm for safety light grid with protected field height up to 1200 mm	630 904

Appendix

Check list

The checklist below is intended as an aid in for the following work on a safety light grid of PSEN op4H-SL Series:

- ▶ commissioning,
- ▶ recommissioning, and
- ▶ running the specified regular check.

Note that the check list is not intended to replace the plant-specific safety analysis required for commissioning/recommissioning, nor the resulting inspections and actions.



INFORMATION

Commissioning, recommissioning and regular inspection may only be carried out by qualified personnel.

We recommend that you keep the completed check list and store it with the machine documentation for reference.

No.	Action	OK	NOT OK	Notes
1	Check the category/standards			
	Does the category of the safety light grid match the category required for the plant/machine?			
	Have the standards applicable for the plant/machine been considered?			
2	Check the safety light grid ambient conditions			
	Have the environmental conditions been met (see Ambient conditions [ 14])?			
	Have the technical details been met for all the safety light grid components?			
3	Check access to the hazardous area Are all access points to the danger zone safeguarded by either safety light grids or mechanical safeguards?			
4	Check the minimum distance to hazardous area			
	Has the minimum distance been calculated in accordance with the applicable standards?			
	Has the calculated minimum distance been maintained at all points?			

No.	Action	OK	NOT OK	Notes
5	Check protected field			
	Has the ability to creep underneath the protected field undetected been excluded?			
6	Check safety light grid			
	Make sure that there are no objects in front of the safety light grid (trailing cable, cross-beams, struts, covers, etc.).			
	Make sure that there are no transparent materials between the monitored protected field and the safety light grid (such as the glass panel).			
	Are all the mechanical connections on the safety light grid attached correctly?			
	Are all the electrical connections to the safety light grid wired correctly?			
7	Check the effectiveness of the safety light grid during the hazardous movement Is the safety light grid effective throughout the whole of the plant/machine's hazardous movement?			
8	Check the output circuitry of the programmable safety and control system			
	Have OSSDs been incorporated as required for the desired safety category?			
	Are the switching elements that are connected to the OSSDs (valves, contactors, etc.) monitored with feedback loops?			
	Does the wiring of the OSSDs match the circuit diagram?			
9	Check guard function for protected field of the safety light grid: Violate the protected field at various points: The hazardous movement must be shut down.			
10	Switch off safety light grid Is the hazardous movement stopped immediately when you switch off?			

Identification

The safety light grid's year and month of manufacture is encoded within its serial number.

The serial number is a 9-digit code.

XYYM#####

Legend

X Internal designation (any letter)

YY Year of manufacture

15 = 2015

16 = 2016

17 = 2017

...

M Month of manufacture

A = January

G = July

B = February

H = August

C = March

I = September

D = April

L = October

E = May

M = November

F = June

N = December

Consecutive number within the month

EC declaration of conformity

This product/these products meet the requirements of the directive 2006/42/EC for machinery of the European Parliament and of the Council. The complete EC Declaration of Conformity is available on the Internet at www.pilz.com/downloads.

Representative: Norbert Fröhlich, Pilz GmbH & Co. KG, Felix-Wankel-Str. 2, 73760 Ostfildern, Germany